



ARRI



ARRI MULTICAM SYSTEM

TRULY CINEMATIC MULTI-CAMERA
LIVE PRODUCTIONS

Cinematic Multicam

The ARRI look, with a seamless transmission workflow

Cinematographers strive for a cinematic look; producers seek efficient and flexible workflows. When it comes to live, multi-camera productions, these requirements can conflict. ARRI's response is a simple-to-integrate fiber transmission system developed in partnership with specialist firm DTS. The combination of ARRI cameras and the 1800 fiber backend delivers a cinematic aesthetic with the efficiency of a live transmission system.

Customers can record in-camera for post, finishing, or slow-motion effects, while simultaneously transmitting live HD or UHD/4K signals to a broadcast facility, stage displays, or social media channel, using standard production environments like OB vans or studios. The ARRI Multicam System knits a variety of components together to give program-makers flexibility tailored to their needs.



High-end images

- Unsurpassed overall image quality
- Natural colors & flattering skin tones
- Highest dynamic range of over 14 stops
- ARRI Look Library & 3D LUT support

Cutting-edge broadcasts

- Live HDR in PQ or HLG
- 4K UHD recording & outputs
- 200 fps slow motion with in-camera recording
- Transmission distance up to 2 km incl. power

Flexible workflows

- Compatibility with Sony RCP controls
- Remote iris control for PL/B4/EF/cine lenses
- Tally interface & intercom/prompter channels
- Return video & genlock support*

* AMIRA Live and AMIRA



AMIRA **LIVE**

Purpose-designed Super 35 live TV camera

Designed specifically for live, multi-camera applications, AMIRA Live features internal cabling between the camera body and the 1820 Fiber Camera Adapter. The resulting camera configuration is clean, uncluttered, reliable, and perfect for live broadcast environments, especially in tandem with the ARRI Viewfinder Multicam Monitor VMM-1.

With its cable-less design, AMIRA Live has more in common with the system cameras typically used for multi-camera broadcasts, but unlike those cameras, AMIRA Live features a Super 35 format ARRI sensor. This unique combination of system camera efficiencies and truly cinematic images, with shallow focus, rich textures, and natural colors, puts AMIRA Live in a class of its own.



- Elimination of external cables between AMIRA Live & the fiber backend
- Ideally suited to multi-camera live broadcasts
- Faster setup of the camera system
- Reduced risk of accidental cable disconnection or damage
- Cleaner camera configuration is easier to work with for camera operators
- Versatile 10-inch Viewfinder Multicam Monitor VMM-1



AMIRA[®]

Adaptable to varied production types

For content creators whose production environments extend beyond multi-camera live broadcasts, the standard AMIRA remains a compelling option. The ergonomic design, optimized for shoulder-mounted operation, suits documentary-style magazine shows, home stories, and live feeds, while support for full audio recording facilitates drama-style productions with small, efficient crews.

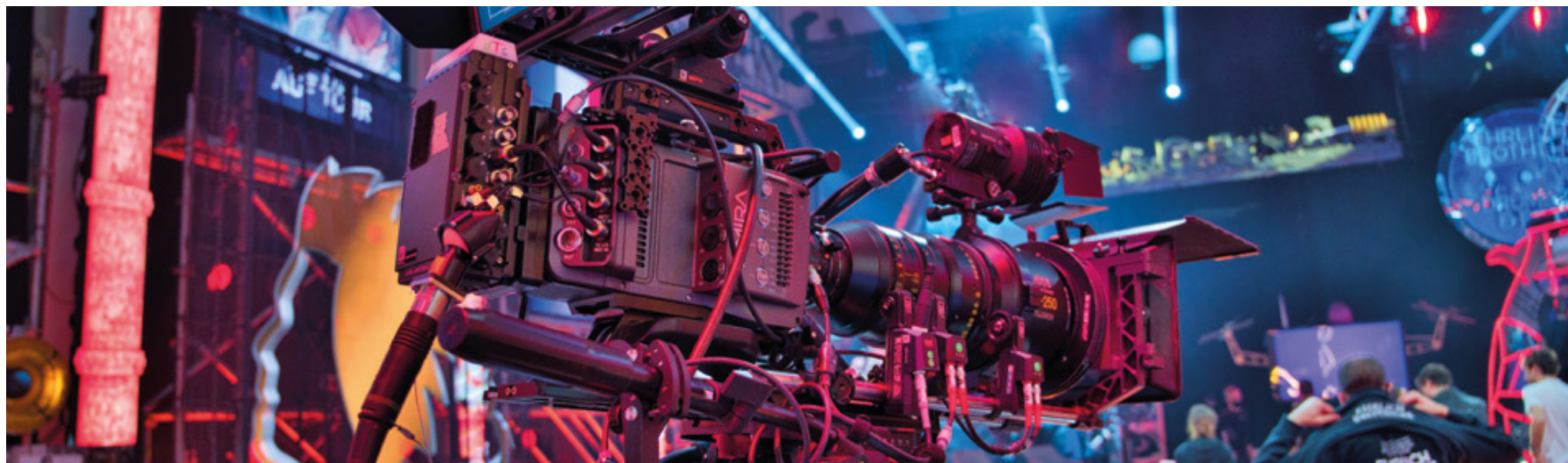

ALEXA[®] MINI

Ideal for all kinds of specialized shots

With its compact and lightweight carbon body, the ALEXA Mini is one of the most versatile, maneuverable cinema cameras ever made. A huge range of available accessories makes it endlessly configurable – perfect for cranes, remote heads like the ARRI SRH-360, and stabilizers such as ARRI TRINITY, artemis, or Steadicam. The optional 4:3 recording license retains maximum image quality when using anamorphic lenses.





EHRlich BROTHERS

“The ARRI cameras have left an amazing impression on me, because of their incomparable quality. The brilliance, the depth of field, and the images are unique to such an extent that the whole crew had to adapt.”

Rolf Sturm, TV director (BVR)

Magic Show | TV Production



DAVID GUETTA

“Using the unparalleled dynamic range of the ARRI cameras on a challenging live production gave us flexibility to create the ultimate look for our show... The impressive color space, range, and never-doubtful performance of the cameras truly contributed to a cinematic style.”

Remco Evers, executive creative director NOMOBO.TV

Concerts | Live Stream

COACHELLA

“We used a combination of the ARRI AMIRAs and the ALEXA Mini in a multi-camera format. It was a real game-changer and an eye-opener for the broadcast crew. It just looked beautiful, especially with daytime exteriors in high-contrast situations.”

Kenny Stoff, director/DP

Music and Arts Festival | Live Concert | Live Event



rbb

“I was very pleased that we used four ARRI AMIRAs. The setup was intuitive and suitable for a fast-paced talk show with a lot of quick changes. Even looking through the viewfinders it was clear that we were getting a completely different, cinematic look, which is unheard of on a talk show.”

DP Fabian Welther, RBB regional public-broadcasting TV channel

Live TV Production





vpsmedia
Film und Fernsehproduktion

“The most important advantages of AMIRA are definitely the picture quality and its versatility. In the past, our cameras were separated between multicam or reports on the one side and image films or scenic productions on the other. Now we no longer need two types of cameras, only the AMIRAs.”

Andreas Schech, VPS Media

Live Concerts | Live Events | Commercials | Corporate Productions



湖南广播电视台
Hunan Broadcasting System

“We preferred AMIRA's large sensor, high resolution, and of course its high dynamic range, which helped us bring some exciting new strength to the show. After shooting with the camera for two seasons, we have gained a lot of valuable experience.”

Lihong Zhou, technical director, Hunan Television

Live TV Production

PHOTOCINELIVE

“Our customers are very demanding. They always try to find ways to make their coverage different. What producers want is a genuinely cinematic look.”

Albrecht Gerlach, PhotoCineLive

Live Fashion Shows | Concerts



Disneyland
PARIS

“Right from the first footage, we were seduced by the result. There was something unique about the texture. ARRI brought us the nobility of the cinematic image that we needed in order to offer the audience a unique entertainment.”

Director of productions Andy Standley, Disneyland Paris

Musical





Audience engagement through HDR

ARRI cameras capture everything you need

14+ STOPS

DOLBY PQ

HLG

BT.2100

ARRI digital cameras have always been HDR capable – an important consideration for today’s broadcasters. The industry-leading 14+ stops of dynamic range captured by all ARRI Multicam System cameras provides the perfect starting point for HDR grading and distribution in either Dolby PQ or HLG formats. HDR with ARRI cameras allows for even better overall image quality – higher contrast with deeper blacks and brighter whites; more vibrant colors; extended depth; and a sharper image with finer detail. This enables more looks, greater creativity, and an enhanced audience experience.



ARMIDA

“All recordings take place amongst the famous works of art in these historic buildings. Therefore, special care needs to be taken when handling the technical equipment and especially in choosing the intensity of the lighting. Despite the weak lighting, ARRI technology is able to provide the audience with detailed and lively images.”

Tilo Krause, producer, ARMIDA FILM GmbH, production of classical concerts for German TV channels ZDF and ARTE

Detailed highlights, deep shadows

Amazing dynamic range, even in SDR

Scenes with a high contrast range, which are not possible to capture with conventional broadcast cameras, can be recorded in all their detail thanks to the high dynamic range of the ARRI image sensor. This helps television productions to balance interior lighting and video displays with exterior daylight through windows, or accommodate any other high-contrast studio or location setup.

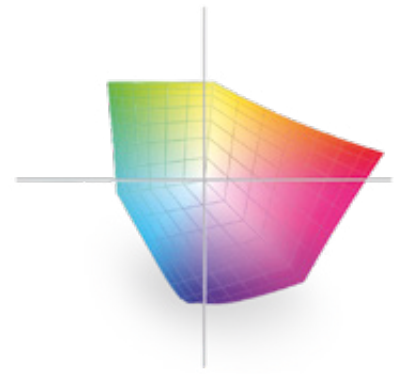

Image capture 1: Shooting with standard 2/3-inch camera



Image capture 2: Shooting with ARRI camera





Look Library looks and 3D LUTS

Creative color palettes – implemented live

Looks from the ARRI Look Library, as well as custom 3D LUTs saved as ARRI Look Files, can be loaded, used, and modified. Unlike other systems, ARRI Multicam allows productions to switch between different looks during a live broadcast. This offers artistic advantages far beyond simply color matching multiple cameras; it permits multi-camera productions to apply pre-graded looks to each setup or location with just the push of a button on the RCP, saving time while increasing creativity and production value. For the first time, live broadcasts can be as bold and sophisticated with color as Hollywood movies.



“This world premiere with the ARRI live looks in a multi-camera network worked flawlessly. The only ‘problem’ we experienced was that we had to make a choice from a variety of great options. ARRI has a library of 288 prepared LUTs and they all look fantastic.”

Thomas Janze, director, “10 Years ARTE Concert” live stream (8 hours), klangmalerei.tv GmbH



ARRI broadcast system and solutions

Integrated tools, unrivalled expertise

The ARRI Multicam System forms part of a wider range of diverse broadcast solutions offered by the company. ARRI's expertise in cameras; lenses; accessories; stabilization tools; lighting; postproduction; and equipment rental brings with it a deep understanding of the production environment, from beginning to end.

This uniquely wide knowledge base makes ARRI the perfect partner for cinematic broadcast applications. The ARRI Multicam System gives program-makers a filmic look in combination with efficient, flexible workflows, while the ARRI System Group provides turnkey solutions for tomorrow's production infrastructures.



Components for the Broadcast Sector



Camera accessories and stabilizers

For heightened control, flexibility, and creativity

ARRI Wireless Video System

The ARRI Wireless Video System (WVS) comprises a video transmitter and two video receiver options, as well as numerous accessories. The system components, which facilitate different configurations for varying shooting needs, include mounting brackets, antenna extensions, the handheld Director's Monitor Support DMS-1, and a specially adapted Transvideo monitor with built-in receiver for the ARRI transmitter. Whether using this monitor or others, the modular system allows for a compact and efficient setup. An extra power-out on the video receiver, for example, permits a single on-board battery to power both the receiver and an attached handheld monitor. A higher input voltage range allows more flexibility when it comes to battery choice.

The high-performance video transmission provides a robust radio link and fast re-link with a long-range, uncompressed, safely encrypted signal. Audio, timecode, and REC flag are included in the zero-delay signal, and up to four receivers can be used per transmitter.

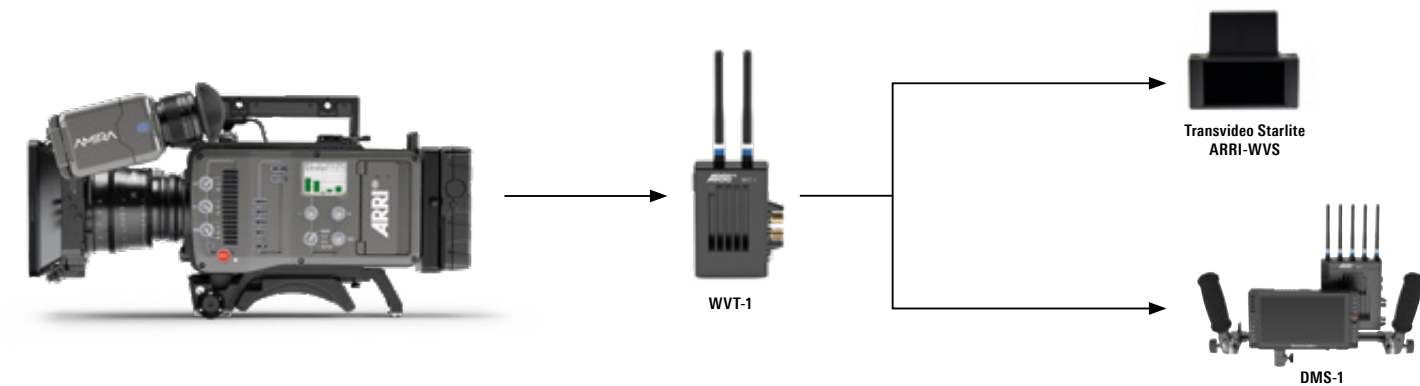

Master Grips

ARRI Master Grips combine effective camera stabilization with comprehensive lens and camera control. They provide full control of focus, iris, and zoom settings on cine lenses, including adjustable motor speed, zoom response, and motor limits. They also offer a comfortable way to control the integrated servo motors of ENG and EF lenses. Mounted on tripod pan bars or studio pedestal heads, the Master Grips can be perfectly used as focus and zoom demands for multi-camera setups.

- ENG/EF/cine lens control
- Advanced camera control
- Solid mechanical design
- Proven ergonomics
- Intuitive user interface
- Multi-lingual display

Stabilized Remote Heads SRH-3 and SRH-360

The SRH-3 and SRH-360 are three-axis, fully stabilized remote heads that allow live productions to achieve extraordinary camera angles and moves with ease and flexibility. Whether in a TV studio or at an event, the SRH-3 and SRH-360 are quick to set up, balance, and configure to personal operator preferences. Together with digital controllers such as the ARRI Digital Remote Wheels DRW-1, Digital Encoder Head DEH-1, and Master Grips, they offer precise control and unrivalled creative versatility.

Both remote heads can be combined with ARRI CSS accessories such as the SAM camera dovetail plates and external radio module ERM-2400 SRH, allowing increased range and reliability of wireless communication. SRH-3 owners can upgrade to the SRH-360 for continuous 360-degree motion on the pan axis, thanks to a newly designed slip ring.



- Smart, adaptive & modular system
- High payload, low weight, compact design
- Best stabilization & compensation of extreme forces
- Various options for remote operation
- Budget friendly
- Future-proof LBUS communication & network integration



TRINITY

TRINITY is the first hybrid camera stabilizer that combines classic mechanical stabilization with advanced active electronic stabilization. This combination results in five axes of control and enables uniquely fluid, wide-ranging, and precisely controlled movements for unrestricted shooting and total creative freedom.

- High-torque brushless motors
- Payload capacity up to 30 kg/66 lb
- Fast & easy setup
- Upgradeable, future-proof design
- Hot-swap technology



artemis Cine Broadcast

The ARRI artemis for cine and broadcast applications is a highly modular and upgradable mechanical stabilizer. Available with wide range of different ARRI CSS components and accessories, it covers the entire spectrum of today's broadcast and filmmaking requirements.

Besides the traditional functions of artemis HD systems, such as high-capacity camera power supply and hot-swap technology, additions to the stabilizer include two high-quality HD-SDI video lines as well as D-Tab and USB power outputs, providing new possibilities and more robust backup options.

High-quality LED lights For live broadcasts and beyond

Lighting design for modern studios in broadcast and media has been greatly impacted by the transition to LED technology, as well as the latest camera developments. HDTV standards, which make extensive use of CMOS technologies and FPGA image processing, demand better lighting quality. ARRI offers a complete LED ecosystem, consisting of a wide range of lights and accessories that speed up lighting workflows. A portfolio of high-quality luminaires such as Orbiter, SkyPanel, and the L-Series covers any application in live broadcasting and beyond, offering full control over the shape, quality, intensity, or color of the light. With the addition of Stellar, ARRI's lighting control app, using these professional lighting fixtures has become faster, easier, and more intuitive than ever before. Ongoing firmware and LiOS (Lighting Operating System) updates for the fixtures complete the system and allow for new features that meet the ever-changing demands of HD, UHD/4K, and HDR multi-camera productions.

LED Ecosystem



The range of ARRI System Group services

- Consultancy
- Concept design
- 3D visualizations
- Project planning
- Integration management
- Training
- After-sales care

ARRI System Group Professional systems integration

ARRI's cross-disciplinary competence is exemplified in the ARRI System Group. The team's knowledge of modern studio design influenced the features of the ARRI LED lighting range, while advancements in camera technology affect their lighting designs for studios. Headquartered in Berlin and with offices in London, Los Angeles, Dubai, and Hong Kong, the ARRI System Group supports clients worldwide. Its comprehensive service offerings are available for projects of any size, from small-scale system upgrades to complete turnkey installations at multi-studio facilities.

Multicam components

For efficient and cost-effective workflows

AMIRA Live



K0.0039136 AMIRA LIVE Camera Set

Features: UHD (3840 x 2160) 1080i and 1080p; frame rates 0.75-200 fps; recording formats ProRes 422 (LT), 422, 422 (HQ) in Rec 709 and Log C; unlimited look functions; import looks; import custom 3D LUTs; in-camera adjustable image parameters for knee, gamma, saturation, and others; ASC CDL in-camera grading; focus and exposure control tools; dynamic auto tracking white balance; Bluetooth audio monitoring; pre-record function; intervalometer; Multicam support; S16 lens mode; camera remote control, ARRI Look Library.

Includes:

- KK.0038511** AMIRA LIVE body (incl. CL kit K2.0023813)
- 10.0001093** AMIRA Advanced licence
- 10.0003723** AMIRA UHD license
- 10.0014641** ARRI Look Library license key

No viewfinder, no lens mount, no camera base mount included.



AMIRA

K0.0001090 AMIRA Camera Set Eco

Features: 1080i & 1080p; frame rates 0.75-100 fps; recording formats ProRes 422 (LT) and 422 in Rec 709 and Log C; basic looks included; unlimited look functions; import looks; import custom 3D LUTs; in-camera adjustable image parameters for knee, gamma, saturation, and others; focus and exposure control tools; intervalometer; Multicam support; S16 lens mode, custom 3D LUTs, camera remote control.

Includes:

- K1.71700.0** AMIRA camera body (incl. viewfinder mount, viewfinder cable (short/long), camera handle)
- K2.75004.0** AMIRA viewfinder MVF-1

K0.0001091 AMIRA Camera Set Advanced

Additional features: frame rates 100-200 fps; ProRes 422 (HQ) recording in Rec 709 and Log C; ASC CDL in-camera grading; dynamic auto-tracking white balance; Bluetooth audio monitoring; pre-record function.

Includes:

- K1.71700.0** AMIRA camera body (incl. viewfinder mount, viewfinder cable (short/long), camera handle)
- K2.75004.0** AMIRA viewfinder MVF-1

K0.0014798 AMIRA Camera Set Premium

Additional features: 2K (2048 x 1152), UHD (3840 x 2160); ProRes 4444 & 4444 XQ, ARRI Look Library

Includes:

- K1.71700.0** AMIRA camera body (incl. viewfinder mount, viewfinder cable (short/long), camera handle)
- K2.75004.0** AMIRA viewfinder MVF-1
- 10.0003723** AMIRA UHD license
- 100.014.641** ARRI Look Library license key

ALEXA Mini



K0.0014799 ALEXA Mini

Features: 35 format film-style digital camera with lightweight and compact carbon body, 4:3/16:9 switchable active sensor area, support for ARRI MVF-1 viewfinder, built-in remote control capabilities via ARRI Electronic Control System and WiFi, support for cforce motors, built-in motorized ND filters, interchangeable lens mounts and ARRI Lens Data System.

Includes:

- K1.0003873** ALEXA Mini body
- 10.0014640** ALEXA Mini ARRI Look Library license key

K0.0014797 ALEXA Mini with 4:3 and ARRIRAW

Includes:

- K1.0003873** ALEXA Mini body
- 10.0008148** ALEXA Mini ARRIRAW license key
- 10.0008147** ALEXA Mini 4:3 license key
- 10.0014640** ALEXA Mini ARRI Look Library license key

Lens Mounts

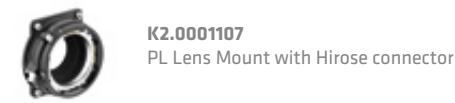

K2.0001107
PL Lens Mount with Hirose connector

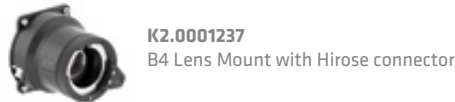

K2.0001237
B4 Lens Mount with Hirose connector

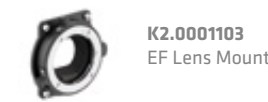

K2.0001103
EF Lens Mount

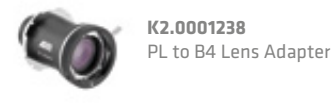

K2.0001238
PL to B4 Lens Adapter

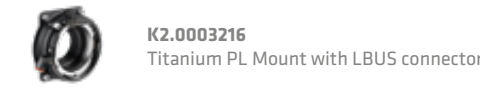

K2.0003216
Titanium PL Mount with LBUS connector

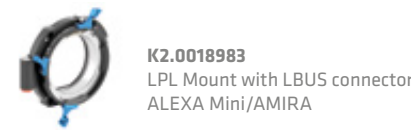

K2.0018983
LPL Mount with LBUS connector
ALEXA Mini/AMIRA

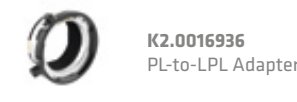

K2.0016936
PL-to-LPL Adapter

*only for AMIRA

AMIRA/AMIRA Live Accessories

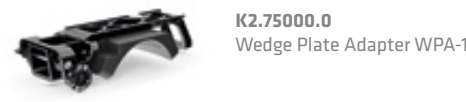

K2.75000.0
Wedge Plate Adapter WPA-1

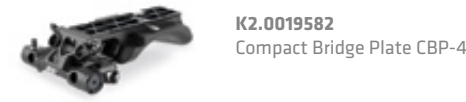

K2.0019582
Compact Bridge Plate CBP-4



K2.75006.0
Bridge Plate Adapter BPA-3

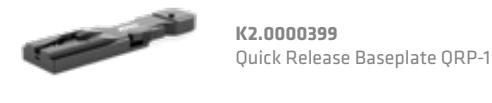

K2.0000399
Quick Release Baseplate QRP-1

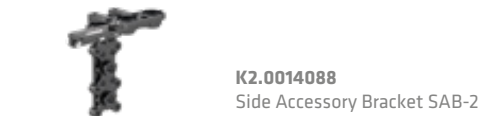

K2.0014088
Side Accessory Bracket SAB-2

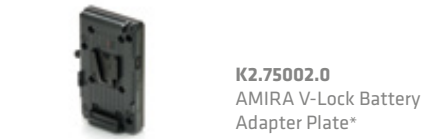

K2.75002.0
AMIRA V-Lock Battery
Adapter Plate*



K2.75001.0
AMIRA Gold Battery Adapter*



K2.0022569
Camera Dock*

ALEXA Mini Accessories

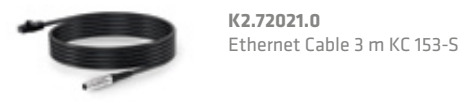

K2.72021.0
Ethernet Cable 3 m KC 153-S

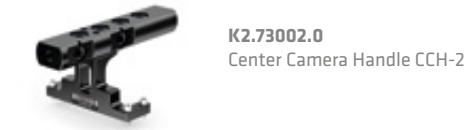

K2.73002.0
Center Camera Handle CCH-2



K2.0006347
ALEXA Mini Adapter Plate
MAP-2



K2.0006140
ALEXA Mini Viewfinder
Bracket MVB-1

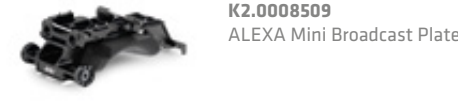

K2.0008509
ALEXA Mini Broadcast Plate

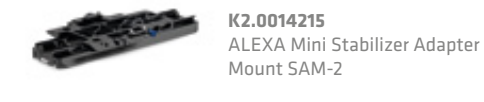

K2.0014215
ALEXA Mini Stabilizer Adapter
Mount SAM-2

ALEXA Mini Accessories

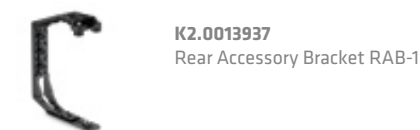

K2.0013937
Rear Accessory Bracket RAB-1



K2.0014126
RAB-1 Clamp



K2.0014531
ALEXA Mini V-Mount Adapter
Plate Mk II



K2.0014533
ALEXA Mini Gold Mount Adapter
Plate Mk II

Monitors



K0.0010097
AMIRA Camera Control
Panel CCP-1 Set



K2.75004.0
AMIRA Viewfinder MVF-1

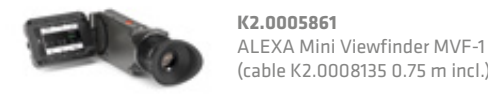

K2.0005861
ALEXA Mini Viewfinder MVF-1
(cable K2.0008135 0.75 m incl.)



K0.0039106
Multicam Monitor Bundle
VMM-1 & MYS-1:
• K2.0023813 Viewfinder
Multicam Monitor VMM-1
• K2.0037636 Monitor
Yoke Support MYS-1

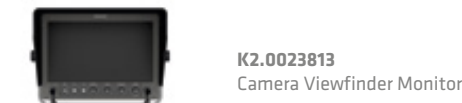

K2.0023813
Camera Viewfinder Monitor

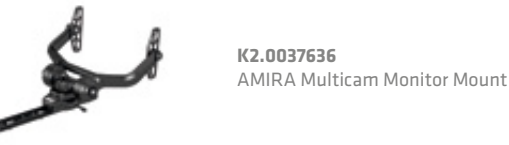

K2.0037636
AMIRA Multicam Monitor Mount

Microphone



K2.0004024
AMIRA Onboard Microphone Set



K2.75005.0
AMIRA Microphone Holder Bracket
MHB-2

Media

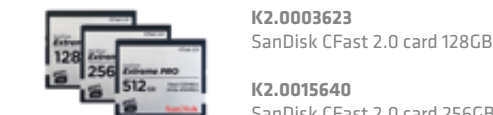

K2.0003623
SanDisk CFast 2.0 card 128GB
K2.0015640
SanDisk CFast 2.0 card 256GB



K2.0016648
SanDisk CFast 2.0 card 512GB
K2.0021432
Angelbird CFast 2.0 card 256GB

Multicam Components



- K0.0039163**
AMIRA Live 1800 Camera Chain Set:
 • K2.0039137 FCA 1820-12G DL6G CL
 • K2.0038531 1820-060-251 Frame Mount
 • K2.0022568 1810-U12GSL 1U FBS (4x3G SL12G)
 • K2.0022570 1U FBS Cable Set



- K2.0013648**
1820 FCA Fiber Camera Adaptor 12G



- K2.0014813**
1820 FCA Lemo Assembly



- K2.0014659**
FCA Dual Link 6G Video Input Option



- K2.0021233**
1810 1U Fiber Base Station FBS



- K2.0022570**
1U FBS Cable Set



- K2.0013653**
Sony RCP to 1840 Cable -
3 m serial cable for Sony RCP

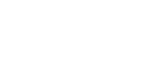

- K2.0019565**
Sony RCP to 1840 Cable -
30 m serial cable for Sony RCP



- K2.0014814**
1810 FCA Cable Set for AMIRA



- K2.0016149**
Cord Control Pod with XLR55 connector



- K2.0021324**
Mounting Bracket for Cord Control Pod



- K2.0013646**
HR30 6pin to 5pin XLR Headset Cable



- K2.0013652**
Tally Box with cable



- K2.0023107**
1801 Fiber Power Interface FPI



- K2.0024328**
Skaarhoj RCP V2

HDR Multicam Log C Workflow for PQ and HLG

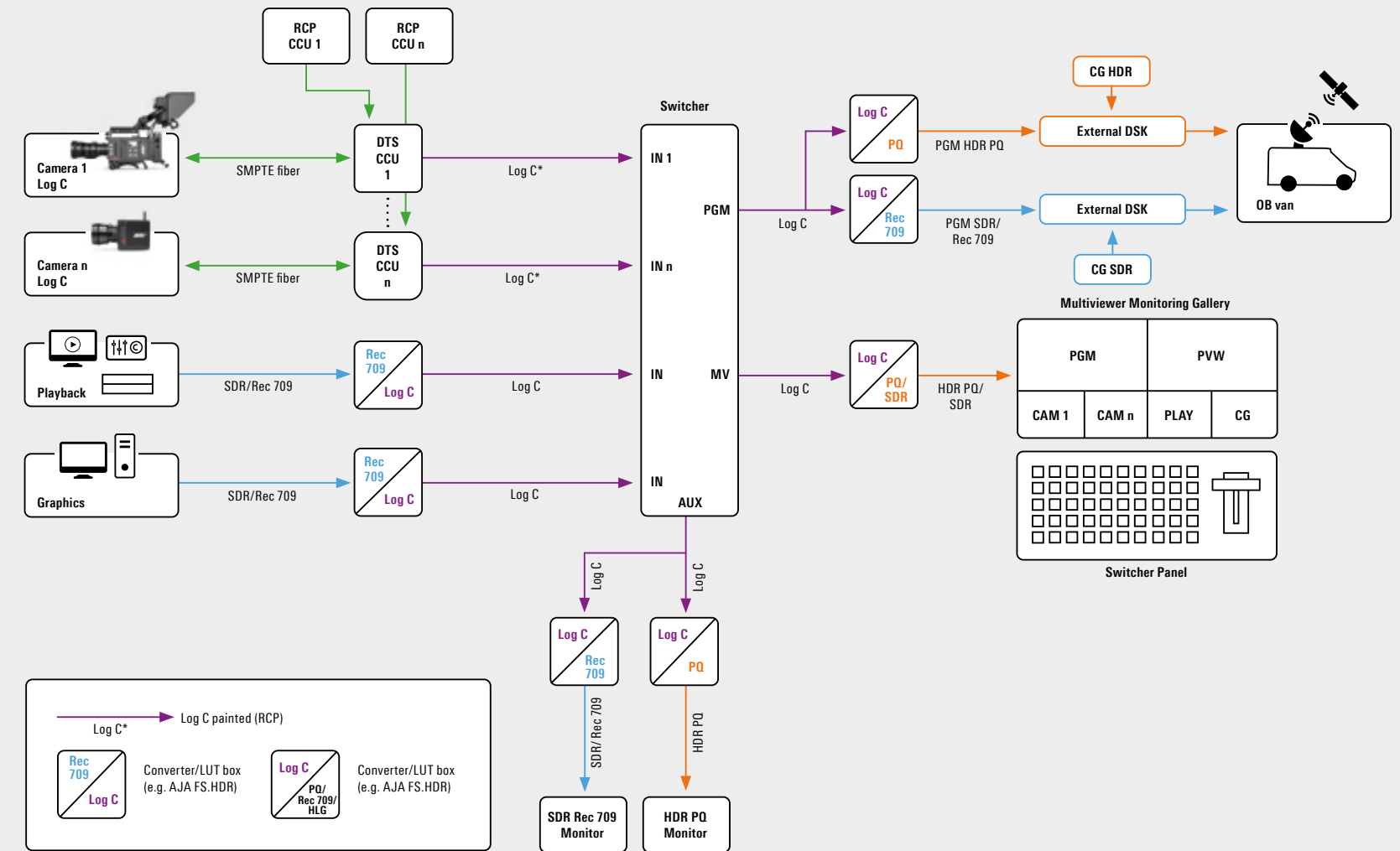

AMIRA Live Multicam setup

Easy integration into broadcast production environments

The AMIRA Live can easily be integrated into existing multi-camera broadcast infrastructures, providing interfaces with controls such as PGM return, tally (green/red), genlock, and more. All video and data signals are transported over a single SMPTE-311 fiber cable, along with power and ethernet/BNC cable connections. Alternatively, wireless (RF) connection provides a completely different video/data transfer option. Parallel with the live SDI output, footage can be recorded in-camera in any format, including Log C, which allows for the retention of all image information throughout the production process.

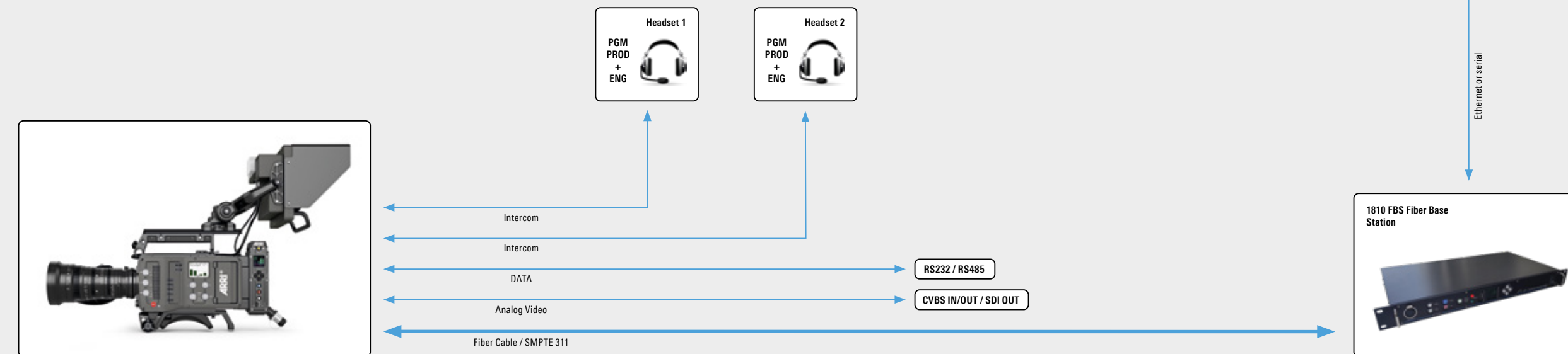

AMIRA Live cameras are controllable with industry-standard Sony RCPs (Remote Control Panels), allowing image parameter and iris control for ENG-style PL and B4 lenses, EF lenses, and also cine-style lenses typically used on high-end cinema and TV productions. An even more flexible and advanced RCP operation is offered with the fully configurable Skaarhoj RCP V2, which supports access to all relevant camera parameters, including LUTs and setup files, through the ARRI Camera Protocol CAP. This represents state-of-the-art RCP operation, far beyond standard RCPs, but maintaining a traditional RCP workflow.

Video OUT:	HD Mode:	2x 1.5G/3G	Intercom:	1x PROD IN / PROD OUT
	UHD Mode:	4x 3G/2SI plus configurable 2x SL12G/2SI or 1x DL6G/2SI or 2x SL6G/2SI		1x ENG IN / ENG OUT CALL
Mon Out:	Analog Video:	2x 1.5G 1080i 2x CVBS OUT	Audio:	1x Analog Stereo OUT 2x AES Audio OUT
	Video IN:	Video Ret. 1x 1.5G 1080i Analog Video: 1x CVBS IN Genlock: 1x BB or Tri-Level Sync Loop Through	Timecode:	1x LTC I/O switchable
			Tally:	Red Tally IN Green Tally IN
			Data:	1x RS485 1x RS232 1x RS422 1x Ethernet (2 connectors)

AMIRA Live Configuration Overview

Lenses Setup

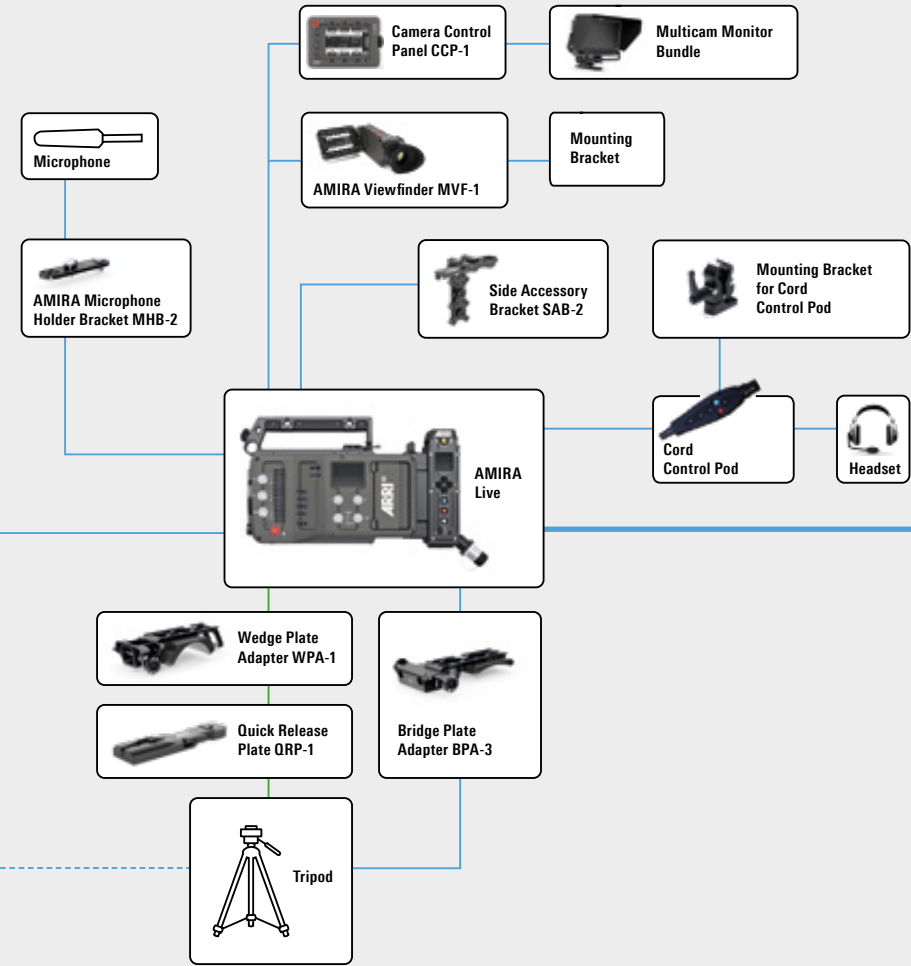
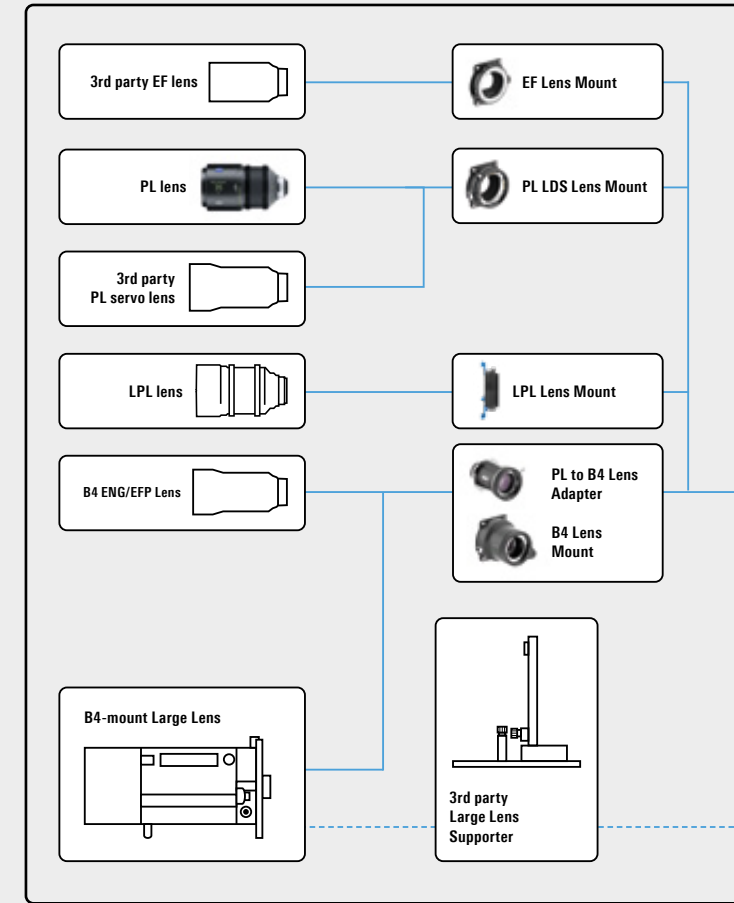

Multi-Camera Setup

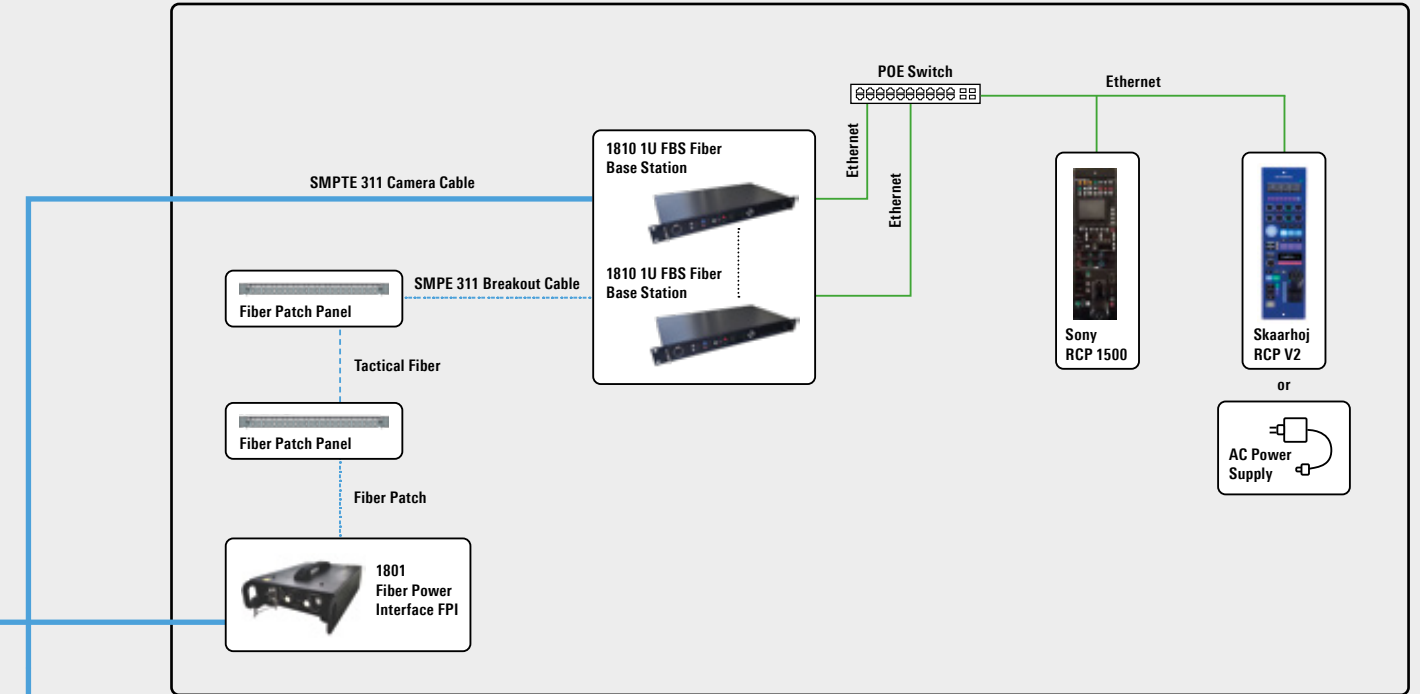

Single-Camera Setup

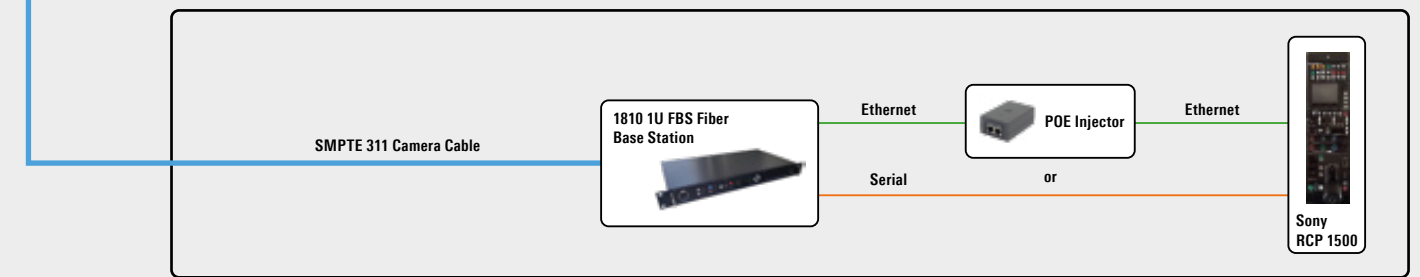

AMIRA Configuration Overview

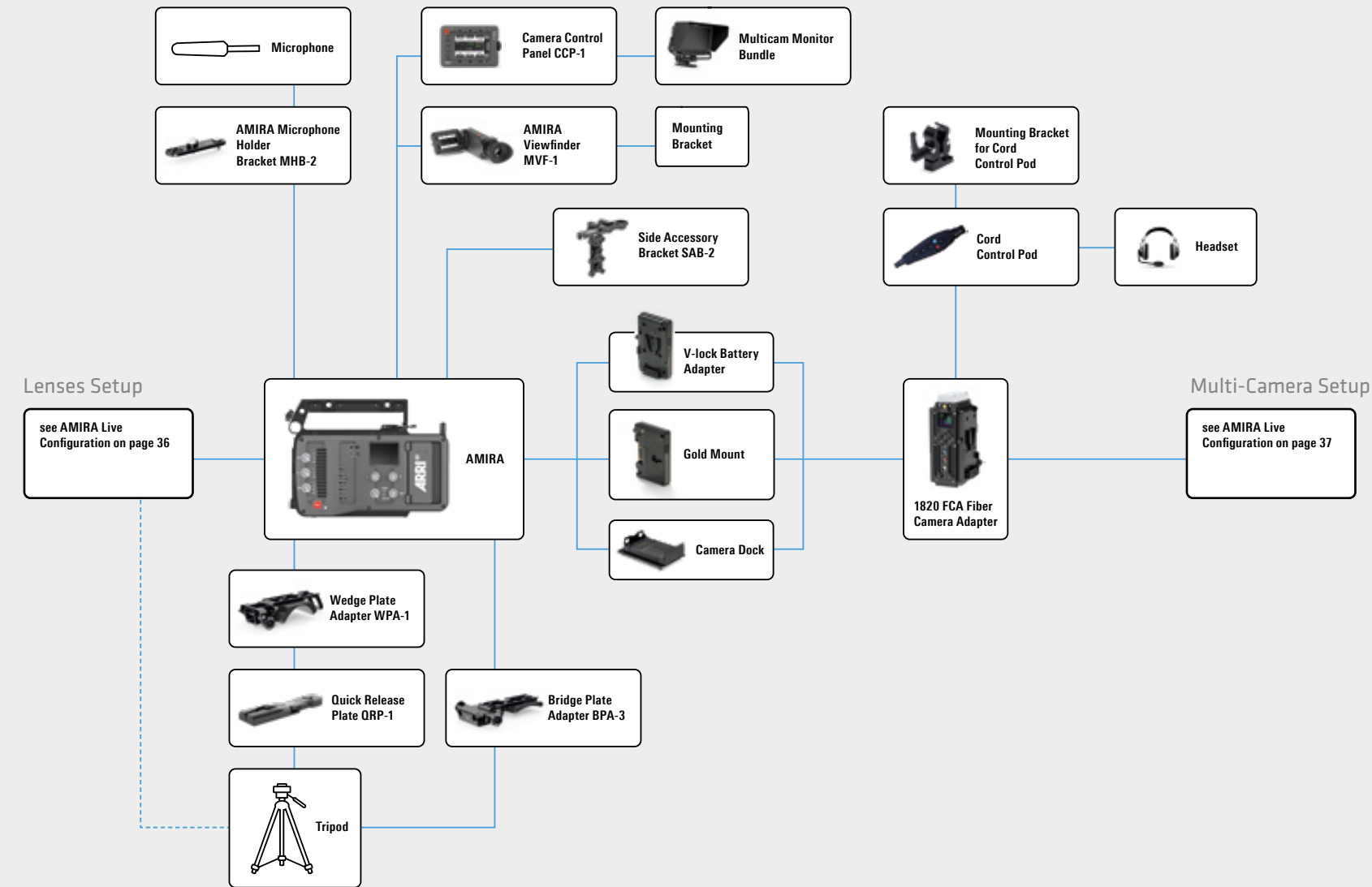

ALEXA Mini Configuration Overview

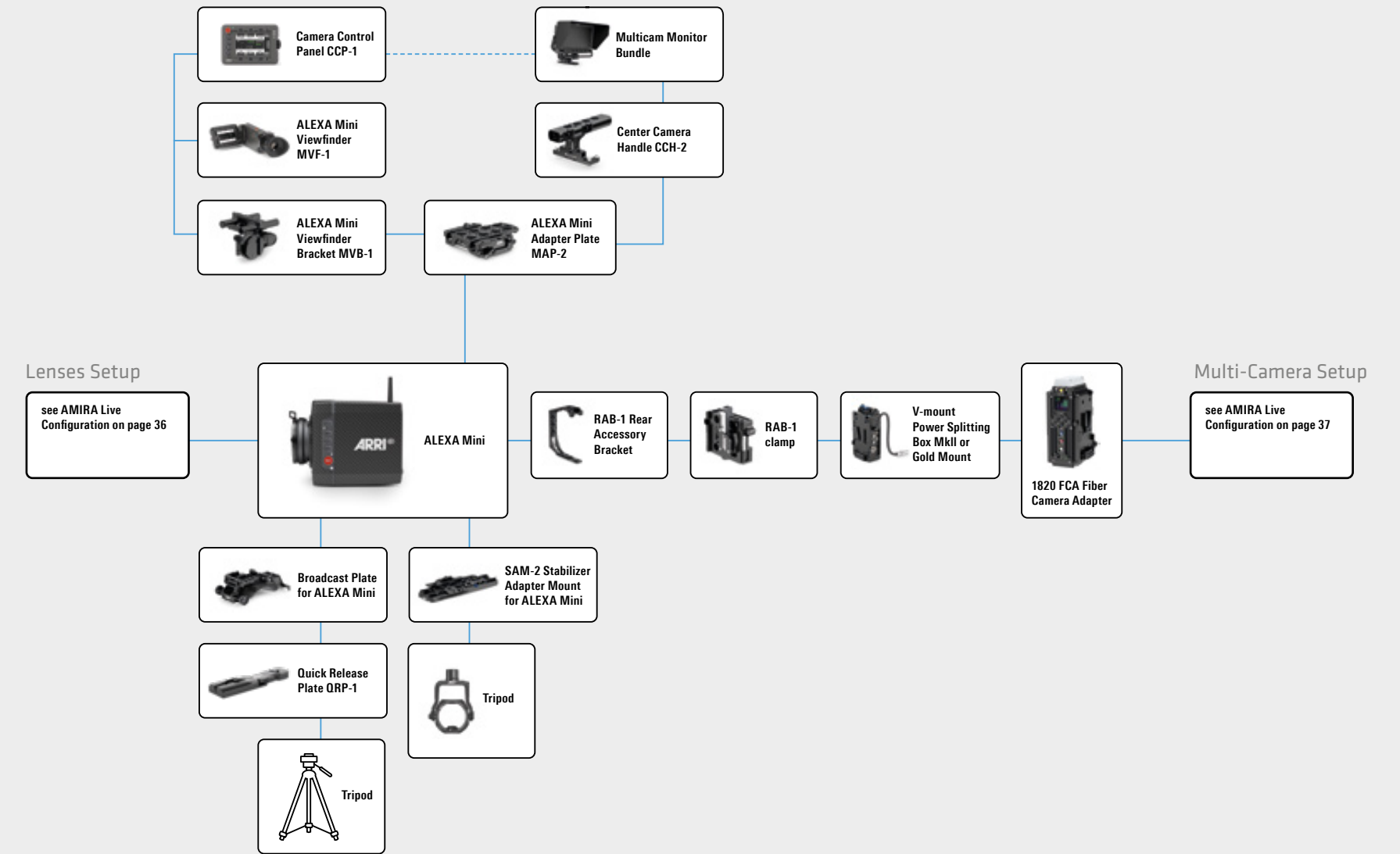

Technical Data ARRI Cameras

	AMIRA Live / AMIRA	ALEXA Mini
Sensor Type	Super 35 mm format ARRI ALEV III CMOS sensor with Bayer pattern color filter array	
Sensor Size	26.40 x 14.85 mm / 1.039 x 0.585", Ø 30.29 mm / 1.193"	
Photosite Pitch	8.25 µm	
Sensor Frame Rates	0.75 - 200fps	
Sensor Active Image Area (photo sites)	S16 HD: 1600 x 900 HD: 2880 x 1620 2K: 2868 x 1612 3.2K: 3200 x 1800 4K UHD: 3200 x 1800 ARRIRAW 16:9 2.8K: 2880 x 1620	S16 HD: 1600 x 900 HD: 2880 x 1620 2K: 2868 x 1612 3.2K: 3200 x 1800 4K UHD: 3200 x 1800 4:3 2.8K: 2880 x 2160 2.39:1 2K Ana.: 2560 x 2145 HD Ana.: 1920 x 2160 ARRIRAW 16:9 2.8K: 2880 x 1620 Open Gate 3.4K: 3424 x 2202
Sensor Active Image Area (dimensions)	S16 HD: 13.20 x 7.43 mm / 0.520 x 0.292" HD: 23.76 x 13.37 mm / 0.935 x 0.526" 2K: 23.66 x 13.30 mm / 0.932 x 0.524" 3.2K: 26.40 x 14.85 mm / 1.039 x 0.585" 4K UHD: 26.40 x 14.85 mm / 1.039 x 0.585" 4:3 2.8K: 23.76 x 17.82 mm / 0.935 x 0.702" 2.39:1 2K Ana.: 21.12 x 17.70 mm / 0.831 x 0.697" HD Ana.: 15.84 x 17.82 mm / 0.624 x 0.702" ARRIRAW 16:9 2.8K: 23.76 x 13.37 mm / 0.935 x 0.526" Open Gate 3.4K: 28.25 x 18.17 mm / 1.112 x 0.715"	S16 HD: 13.20 x 7.43 mm / 0.520 x 0.292" HD: 23.76 x 13.37 mm / 0.935 x 0.526" 2K: 23.66 x 13.30 mm / 0.932 x 0.524" 3.2K: 26.40 x 14.85 mm / 1.039 x 0.585" 4K UHD: 26.40 x 14.85 mm / 1.039 x 0.585" 4:3 2.8K: 23.76 x 17.82 mm / 0.935 x 0.702" 2.39:1 2K Ana.: 21.12 x 17.70 mm / 0.831 x 0.697" HD Ana.: 15.84 x 17.82 mm / 0.624 x 0.702" ARRIRAW 16:9 2.8K: 23.76 x 13.37 mm / 0.935 x 0.526" Open Gate 3.4K: 28.25 x 18.17 mm / 1.112 x 0.715"
Recording File Container Size (pixels)	S16 HD: 1920 x 1080 HD: 1920 x 1080 2K: 2048 x 1152 3.2K: 3200 x 1800 4K UHD: 3840 x 2160 ARRIRAW 16:9 2.8K: 2880 x 1620	S16 HD: 1920 x 1080 HD: 1920 x 1080 2K: 2048 x 1152 3.2K: 3200 x 1800 4K UHD: 3840 x 2160 4:3 2.8K: 2944 x 2160 2.39:1 2K Ana.: 2048 x 858 HD Ana.: 1920 x 1080 ARRIRAW 16:9 2.8K: 2880 x 1620 Open Gate 3.4K: 3424 x 2202
Recording File Image Content (pixels)	ProRes S16 HD: 1920 x 1080 ProRes HD: 1920 x 1080 ProRes 2K: 2048 x 1152 ProRes 3.2K: 3200 x 1800 ProRes 4K UHD: 3840 x 2160 ProRes 4:3 2.8K: 2880 x 2160 ProRes HD Ana.: 1920 x 1080 ProRes 2.39:1 2K Ana.: 2048 x 858 ARRIRAW 16:9 2.8K: 2880 x 1620 ARRIRAW Open Gate 3.4K: 3424 x 2202 ARRIRAW 4:3 2.8K (OG 3.4K): 3424 x 2202 ARRIRAW 2.39:1 2K Ana. (OG 3.4K): 3424 x 2202 ARRIRAW 16:9 HD Ana. (OG 3.4K): 3424 x 2202	ProRes S16 HD: 1920 x 1080 ProRes HD: 1920 x 1080 ProRes 2K: 2048 x 1152 ProRes 3.2K: 3200 x 1800 ProRes 4K UHD: 3840 x 2160 ProRes 4:3 2.8K: 2880 x 2160 ProRes HD Ana.: 1920 x 1080 ProRes 2.39:1 2K Ana.: 2048 x 858 ARRIRAW 16:9 2.8K: 2880 x 1620 ARRIRAW Open Gate 3.4K: 3424 x 2202 ARRIRAW 4:3 2.8K (OG 3.4K): 3424 x 2202 ARRIRAW 2.39:1 2K Ana. (OG 3.4K): 3424 x 2202 ARRIRAW 16:9 HD Ana. (OG 3.4K): 3424 x 2202

*only AMIRA Live

**only AMIRA

	AMIRA Live / AMIRA	ALEXA Mini
Exposure Latitude	14+ stops over the entire sensitivity range from EI 160 to EI 3200 as measured with the ARRI Dynamic Range Test Chart (DRTC-1)	
Exposure Index	Adjustable from EI 160-3200 in 1/3 stops, EI 800 base sensitivity	
Shutter	Electronic shutter, 5.0°- 356° or 1 s - 1/8000 s	
Recording Formats	MXF/ARRIRAW, ProRes 4444 XQ, ProRes 4444, ProRes 422 (HQ), ProRes 422, ProRes 422 (LT), MPEG-2 HD	MXF/ARRIRAW, ProRes 4444 XQ, ProRes 4444, ProRes 422 (HQ), ProRes 422, ProRes 422 (LT)
Recording Media	CFast 2.0 Cards	
Recording Frame Rates	ProRes HD: 0.75 - 200 fps ProRes S16 HD: 0.75 - 200 fps ProRes 2K: 0.75 - 200 fps ProRes 3.2K: 0.75 - 60 fps ProRes UHD: 0.75 - 60 fps ProRes 4:3 2.8K: 0.75 - 50 fps ProRes 2.39:1 2K Ana.: 0.75 - 120 fps ProRes HD Ana.: 0.75 - 120 fps MFX/ARRIRAW 16:9 2.8K: 0.75 - 48 fps MPEG-2 HD: 23.976 - 59.94 fps	ProRes HD: 0.75 - 200 fps ProRes S16 HD: 0.75 - 200 fps ProRes 2K: 0.75 - 200 fps ProRes 3.2K: 0.75 - 60 fps ProRes UHD: 0.75 - 60 fps ProRes 4:3 2.8K: 0.75 - 50 fps ProRes 2.39:1 2K Ana.: 0.75 - 120 fps ProRes HD Ana.: 0.75 - 120 fps MFX/ARRIRAW 16:9 2.8K: 0.75 - 48 fps MFX/ARRIRAW 3.4K Open Gate: 0.75 - 30 fps
Recording Modes	Standard real-time recording, Pre-recording, Intervalometer, Stop Motion	
Viewfinder Type	Multi Viewfinder MVF-1 with 3,2" flip-out monitor, Camera Control Panel (CCP-1) with option to daisy-chain MVF-1	
Viewfinder Technology	OLED viewfinder, LCD fold-out monitor	
Viewfinder Resolution (pixel)	1280 x 720	
Viewfinder Diopter	Adjustable from -5 to +5 diopters	
Color Output	Rec 709, Rec 2020, Log C, Custom Look (ARRI Look File ALF-2)	
Look Control	Import of custom 3D LUT ASC CDL parameters (slope, offset, power, saturation) Knee, gamma, saturation, black gamma, saturation by hue Support of ARRI Look Library	
White Balance	Manual and auto white balance, adjustable from 2,000 K to 11,000 K in 10 K steps Color correction adjustable range from -16 to +16 CC. 1 CC corresponds to 035 Kodak CC values or 1/8 Rosco values	
Filters	Built-in motorized ND filters 0.6, 1.2, 2.1, Fixed optical low pass, UV, IR filter	
Image Outputs	1x proprietary signal output for MVF-1 viewfinder 2x SDI Out via D-SUB 24W7 on camera rear: 1.5G (SMPTE ST292-1), 3G (SMPTE ST425-1, ST425-3), 6G & DL 6G (SMPTE ST2081-10, ST2081-11), uncompressed video with embedded audio and metadata* 2x SDI Out: 1.5G (SMPTE ST292-1), 3G (SMPTE ST425-1, ST425-3), 6G & DL 6G (SMPTE ST2081-10, ST2081-11), uncompressed video with embedded audio and metadata	
Lens Squeeze Factor	1.00, 1.30	1.00, 1.30, 2.00
Exposure and Focus Tools	False Color, Zebra, Zoom, Waveform, Aperture and Color Peaking	
Audio Input	2x XLR 3pin Mic/Line Input with 48 V Phantom Power, switchable to AES3 1x XLR 5pin Mic/Line Input with 48 V Phantom Power (Line input max. level +24 dBu correlating to 0 dBFS) Bluetooth whisper track	1x LEMO 5pin balanced stereo line in (Line input max. level +24 dBu correlating to 0 dBFS)
Audio Output	3.5 mm stereo headphone jack, Bluetooth audio, SDI (embedded)	
Audio Recording	4 channel linear PCM, 24 bit 48 kHz, 1 channel Bluetooth whisper track	
Remote Control Options	Web-based remote control from phones, tablets and laptops via WiFi & Ethernet Camera Access Protocol via Ethernet & WiFi GPIO interface for integration with custom control interfaces	Web-based remote control from phones, tablets and laptops via WiFi & Ethernet Camera Access Protocol via Ethernet & WiFi GPIO interface for integration with custom control interfaces WCU-4 hand unit with control over lens motors and operational parameters via built-in white radio

Technical Data ARRI Cameras

	AMIRA Live / AMIRA	ALEXA Mini
Audio Output	3.5 mm stereo headphone jack, Bluetooth audio, SDI (embedded)	SDI (embedded)
Audio Recording	4 channel linear PCM, 24 bit 48 kHz, 1 channel Bluetooth whisper track	2 channel linear PCM, 24 bit 48 kHz
Remote Control Options	Web-based remote control from phones, tablets and laptops via WiFi & Ethernet Camera Access Protocol via Ethernet & WiFi GPIO interface for integration with custom control interfaces	Web-based remote control from phones, tablets and laptops via WiFi & Ethernet Camera Access Protocol via Ethernet & WiFi GPIO interface for integration with custom control interfaces WCU-4 hand-unit with control over lens motors and operational parameters via built-in white radio
Interfaces	1x D-SUB 24W7 (LTC Timecode, Ret/Sync In, Genlock, Ethernet, Power In)* 1x BNC LTC Timecode In/Out ** 1x BNC SDI Ret/Sync In (opt. separate analog Genlock In) ** 1x LEMO 6pin EXT multi purpose accessory interface 1x Hirose 12pin (on PL lens mount) 1x RJ45 Ethernet for remote control and service ** 2x USB 2.0 (for user setups, look files etc)	1x LEMO 5pin LTC Timecode In/Out 1x LEMO 10pin Ethernet for remote control and service 1x BNC Sync In (optional activation through ARRI Service) 1x LEMO 7pin EXT multi-purpose accessory interface w. RS pin and unregulated power output (outputs battery voltage) 1x LEMO 4pin LBUS (on lens mount) for lens motors, daisy chainable 1x USB 2.0 (for user setups, look files etc)
Wireless Interface	Built-in WiFi module (IEEE 802.11b/g), Built-in Bluetooth module	Built-in WiFi module (IEEE 802.11b/g), Built-in White Radio for ARRI lens and camera remote control
Lens Mount	PL mount with Hirose connector and LDS EF mount B4 mount with Hirose connector LPL mount with LBUS connector Leitz Cine Wetzlar M mount	Titanium PL mount with LBUS connector LPL mount with LBUS connector PL mount with Hirose connector EF mount B4 mount with Hirose connector Leitz Cine Wetzlar M mount
Flange Focal Depth	PL mount 52 mm, LPL mount 44 mm	
Power Input	10.5-34 V DC via D-SUB 24W7 on camera rear* 1x LEMO 8pin (10.5-34 V DC)** 1x On-board battery interface (10.5-24 V DC) **	1x LEMO 8pin (10.5-34 V DC)
Power Consumption	min. 52 W, max. 84 W (camera body with MVF-1)	min. 43 W, max. 84 W, (camera body)
Power Outputs	1x Fischer 3pin 24 V RS 1x LEMO 2pin 12 V 1x Hirose 4pin 12 V 1x LEMO 6pin EXT 24 V	1x LEMO 7pin EXT unregulated power output (outputs battery voltage) with max. 1.1 A
Power Management	Active ORing between BAT connector and onboard battery adapters	-
Measurements (HxWxL)	182 x 147 x 374 mm / 7.2 x 5.8 x 14.7" (camera body with 1820 Fiber Adapter and PL lens mount)* 149 x 139 x 309 mm / 5.8 x 5.4 x 12.1" (camera body with PL lens mount) **	140 x 125 x 185 mm / 5.5 x 4.9 x 7.3" (camera body with PL lens mount)
Weight	- 5.2 kg / - 11.5 lb (camera body with 1820 Fiber Adapter and PL lens mount)* - 4.1 kg / - 9.2 lb (camera body with PL lens mount) **	- 2.3 kg / - 5 lb (camera body with titanium PL lens mount)
Operating Temperature	-20° C to +50° C / -4° F to +122° F @ 95% relative humidity max, non condensing, splash and dust proof through sealed electronics **	-20° C to +45° C / -4° F to +113° F @ 95% relative humidity max, non condensing, splash and dust proof through sealed electronics
Storage Temperature	-30° C to +70° C / -22° F to 158° F	
Sound Level	< 20 dB(A) at 24 fps	
Software License Keys	AMIRA Advanced, AMIRA Premium, AMIRA 4K UHD, AMIRA ARRIRAW, ARRI Look Library (weekly or permanent)	ALEXA Mini 4:3, ALEXA Mini ARRIRAW, ARRI Look Library

*only AMIRA Live

**only AMIRA

Technical Data 1800 Fiber System

	AMIRA Live	AMIRA and ALEXA Mini with 1800 Fiber System
Mechanics/Power		
SMPTE 311M Cable Length	about 2 km	about 2 km
Camera Power	100 W Camera Power (150 W total internal power)	100 W Camera Power (150 W total internal power)
Fiber Adaptor Weight	integrated	1.1 kg
Fiber Adaptor Volume	integrated	1110 cm ³
Base Station Weight	2.1 kg	2.1 kg
Base Station Dimensions (HxWxL)	43 x 429 x 275 mm	43 x 429 x 275 mm
Fiber Adaptor Dimensions (HxWxL)	integrated	189 x 105 x 65 mm
Base Station Volume	4644 cm ³	4644 cm ³
Base Station Video Out		
QL3G 4K@60P, DL3G, 2 x SL3G	4 x BNC	4 x BNC
2 x SL12G, DL6G, 2 x SL6G & 2x SL3G	2 x 12G BNC	2 x 12G BNC (option)
2 x 1.5G Monitor Out	2 x BNC	2 x BNC
2 x Composite Video Out	2 x BNC	2 x BNC
Base Station Video In		
1.5G Ret Video & Sync	1 x BNC	1 x BNC
Analogue Genlock Black/Burst, Tri Level (Loop through)	2 x BNC	2 x BNC
Composite Return For QTV/Teleprompter	1 x BNC	1 x BNC
Base Station Audio Out		
Audio on all Programme Video Out	Embedded	Embedded
Analogue Audio	XLR5 Male	XLR5 Male
2 x AES Audio	2 x BNC	2 x BNC
Base Station I/O		
LTC Timecode In/Out	1 x BNC	1 x BNC
RS232/RS422/RS485 (Accessories/ Cam/Lens Control)	2 x 9W-D & 1 x 15W-D	2 x 9W-D & 1 x 15W-D
Ethernet Cam Control	2 x RJ45	2 x RJ45
Intercom PD/ENG (2 Channels) & Call	1 x 15W-D	1 x 15W-D
Red & Green Tally	1 x 9W-D	1 x 9W-D
Fiber Adaptor In		
DL3G, 2 x SL3G & 2 x 1.5G In	internal	Din 1.0/2.3
Composite Video Input	-	BNC
External 12-17 V IN, Camera Powered Locally	PWR In - Lemo	V-Lock or Gold Mount
Fiber Adaptor Out		
2 x Red & Green Tally	12W HR-30 & 10W HR-30	12W HR-30 & 10W HR-30
Composite Video QTV/Teleprompt Out	12W HR-30 or 10W HR-30	12W HR-30 or 10W HR-30
1.5G Return Video/Sync Out	-	Din 1.0/2.3
Analogue GL Black & Burst/Tri Level	-	BNC
2 x 1.5G Monitor Out	-	Din 1.0/2.3, Din 1.0/2.3 Return Switch
3G Monitor Out	BNC	BNC
+12 V VF Power 12 V / 24 W Viewfinder Power Out	12 W HR-30	12 W HR-30
+12 V AUX Power 12 V / 50 W Power Output	3 W HR-30	3 W HR-30
Program Audio AES Out	10 W HR-30	10 W HR-30
Camera Power Out	internal	V-Lock, Gold Mount
Fiber Adaptor I/O		
LTC Timecode	internal	BNC
RS232/RS422/RS485 (Accessories/Cam/ Lens Control)	10 W HRS, 12 W HRS & 6 W HRS	10 W HRS, 12 W HRS & 6 W HRS
Ethernet Cam Control	internal	RJ45
Intercom PD & ENG (2 Channels)	2 x 6 W HRS	2 x 6 W HRS



ARRI Academy Strengthen your knowledge

Certified training courses, bespoke one-on-one tuition, masterclasses, and close-up events

Offering a wide range of multi-day training courses, individual sessions, and educational events in different countries and languages worldwide, ARRI Academy is the best route for users of all abilities to gain hands-on knowledge of ARRI products and workflows, and build their on-set confidence.

Certified online training courses available at MZed.com

Learn all about ARRI camera products through certified online training from industry professionals.
arri.academy/courses-mzed

Preregistration

You can preregister for one or more of ARRI's Certified User and Service Training courses. Let us know how and where we can help; specify your products, time frame, and preferred locations. You can register today without any obligation and, depending on the regional demand, we will schedule a training near you.
arri.academy/preregistration

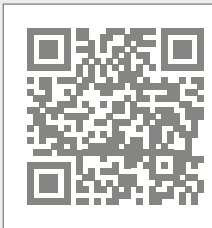

Find out more about all our upcoming courses here:
arri.academy/schedule

For further information, please contact:
ARRI Academy
academy@arri.de
+49 89 3809 2030
www.arri.com/academy

Global service and support

For an international industry

Integration of the ARRI Multicam System into conventional live production environments is seamless, the learning curve is simple, and the entire ecosystem of integrated tools is solidly backed up by ARRI's global support network. ARRI products are renowned all over the world for their precision and durability. Nevertheless, ARRI values the trust of its customers in the company's after-sales service and support as highly as their trust in the equipment itself. With service centers covering the entire globe, staffed by highly trained technicians, we are never too far away to provide the support you need, wherever you might be.



This Cinematic Multicam brochure (80.0040044) is published by Arnold & Richter Cine Technik, March 2021 © ARRI/2021
 Technical data and offerings are subject to change without notice. All rights reserved. Without any warranty. Not binding 03/2021.
 ARRI, Orbiter, **LIOS**, SkyPanel and L-Series are trademarks of Arnold & Richter Cine Technik GmbH & Co. Betriebs KG.



www.arri.com/multicam