

SONY

HDC Series HDC-5500, HDC-3500, HDC-3100, HDC-3170, HDC-P50



SUPER MOTION

SR Live
for HDR

IP Live
Production System

4K

Sony 4K 3-CMOS Camera – Open up a World of Creativity with this New Performance Benchmark

Over the years, Sony has established a powerful solution lineup for HD studio operations with its HDC Series cameras along with a wide range of accessories to enhance your creative options. And now Sony proudly introduces you to next-stage migration with a new camera model featuring Sony's state-of-the-art technologies.

Sony adds the HDC-5500 camera to its lineups of widely accepted HDC Series cameras, with quality far above the industry standard.

The HDC-5500 can directly output 4K signals via a 12G-SDI interface. This amazing performance from a compact unit allows the HDC-5500 to be used, for instance, in a Steadicam system or wireless camera system. Furthermore, Sony developed all-new 4K signal transmission technology specifically for the HDC-5500.

This new UHB transmission system can transmit 4K baseband signals from the camera together with, for example, 4K signals captured by the HDC-P50 point-of-view (POV) style camera system via just a SMPTE fiber cable.

The HDC-P50 can directly output 4K signals or high frame rate signals and therefore offers excellent usability for capturing high-resolution images from a wide range of camera positions such as aerial video shooting.

Together the HDC-5500, HDC-3500, HDC-3100, HDC-3170, and HDC-P50 are powerful tools that truly inspire innovation. All of these HDC Series cameras boast various options such as a stunning 7-inch OLED viewfinder and a large lens adaptor that enables rapid attachment without fine adjustment.

Sony continues to strongly support creators in the image industry and enable their imagination with cutting-edge technologies and the HDC Series.



HDC Series Multi-Format HD Camera System



HDC-5500

Sony developed a powerful new imaging device specifically for the HDC-5500. It offers high sensitivity of F10 (at UHD/59.94p) or F11 (at UHD/50p) and a superior signal-to-noise ratio. Along with this, the HDC-5500 offers enhanced, excellent picture quality through three recently developed cutting-edge technologies. The first of these is a 4K CMOS imaging device equipped with global shutter technology, the second is a dedicated low-power, high-speed signal processor, and the third is a UHB transmission system that can transmit 4K baseband signals from the camera together with, for example, 4K signals captured by the HDC-P50 point-of-view (POV) style camera system via just a SMPTE fiber cable. In addition, the HDC-5500 can output progressive signals as standard and can be upgraded with optional software licenses to add required functions such as progressive segmented frame (PsF) signal output and double-speed acquisition. Furthermore, the HDC-5500 can capture high frame rate (HFR) images of HD 8x*1, 6x*1, 4x, and 3x. This camera can also capture high dynamic range (HDR) images at the same time. This enables simultaneous production of HDR and SDR at an SR-Live event. Joining Sony's widely acclaimed HDC Series family for live production solutions, the HDC-5500 offers similar operability to existing HDC Series cameras and is fully compatible with a wide range of Sony's existing products and workflows, including viewfinders, large lens adaptors, and camera control units. All this helps you to keep down costs and inventory.



HDC-3500, HDC-3100, HDC-3170

The HDC-5500 joins four pre-existing HDC Series cameras: the HDC-3500, HDC-3100, HDC-3170, and HDC-P50.

The HDC-3500 is operated through fiber transmission as standard and has an exchangeable side panel interface; the optional HKC-CN50 side panel attachment kit makes switching easy. To satisfy your varying requirements with the HDC-3500, Sony provides exchangeable adaptors – the HKC-FB30 for fiber transmission and the

Portable Cameras



HDC-5500

Optical-fiber interface
 1080/59.94i, 1080/23.98PsF*2
 1080/24PsF*2, 1080/29.97PsF*2
 1080/59.94p*3, 720/59.94p
 1080/119.88i*4, 119.88p*4, UHD/59.94p*5
 UHD/(23.98p, 24p, 29.97p, 119.88p*6-7)
 1080/(2x, 3x, 4x, 6x*1, 8x*1)*7
 720/(2x, 3x, 4x, 6x, 8x)*7



HDC-3500

Optical-fiber interface
 1080/59.94i, 1080/23.98PsF*2
 1080/24PsF*2, 1080/29.97PsF*2
 1080/59.94p*3
 720/59.94p, 1080/119.88i*4
 720/119.88p*4, UHD/59.94p*3*5



HDC-3100

Optical-fiber interface
 1080/59.94i, 720/59.94p
 1080/23.98PsF*2
 1080/24p*2
 1080/29.97p*2, 1080/59.94p*3
 UHD/59.94p*3*5



HDC-3170

Digital triax interface
 1080/59.94i
 720/59.94p
 1080/59.94p

HKC-TR37 for triax transmission. The HDC-3100 offers an optical fiber transmission capability as standard while the HDC-3170 offers a digital triax transmission capability. Both deliver high sensitivity of F12 (at 1080/59.94i) or F13 (at 1080/50i) so you can select your model according to your anticipated signal wiring setup – optical fiber or triax.

*1 Available in future. *2 Optional HZC-PSF50 software is required. *3 Optional HZC-PRV50 software is required. *4 Double-speed acquisition format for slow-motion *5 Optional HKCU-UHD30 Board is required to be installed into HDCU-3100. *6 Optional HZC-UHD50 software is required. *7 Optional HZC-HFR50 software is required.

HDC Series Cutting-Edge Technologies

Highly Acclaimed 4K 3-CMOS Sensor with Global Shutter Technology (for the HDC-5500 and HDC-3500)

Based on Sony's cutting-edge imaging device technology and the latest on-chip lens structure, this 2/3-inch-type 4K CMOS sensor offers high sensitivity of F10 (at UHD/59.94p) and F11 (at UHD/50p) *¹ for the HDC-5500, and F10 (at 1080/59.94p) and F11 (at 1080/50p)*² for the HDC-3500 at 2,000 lx and a superior signal-to-noise ratio even without digital noise suppression.

In addition, there is a wide variety of available output formats including 1080/59.94i, 1080/50i, 1080/23.98p*³, 1080/24p*³, 1080/25p*³, 1080/29.97p*³, and 1080/59.94p*² or 1080/50p*². These formats exceed HD picture quality made from 4K capturing images.

*¹ Optional HZC-UHD50 software is required for the HDC-5500.

*² Optional HZC-PRV50 software is required for the HDC-3500.

*³ Optional HZC-PSF50 software is required for the HDC-3500.

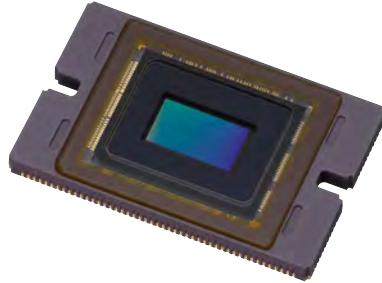

State-of-the-Art Evolving Digital Signal Processor

The DSP LSI developed for the HDC-5500 supports UHD/59.94p and UHD/50p progressive formats, making full use of high-clarity images captured by the CMOS sensor.

You can also capture HFR images and achieve the high-speed signal processing capability that is needed in most compact camera operations.



Optical Fiber Transmission

The HDC-5500 camera and HDCU-5500 system both offer as standard the capability of two 4K signal lines of UHB optical fiber transmission, enabling you to shoot in various capturing formats, and an additional 4k video trunk line. HDC-3500 and HDC-3100 cameras offer an optical fiber transmission capability as standard, enabling you to shoot in various capturing formats. These cameras are equipped with an SMPTE-standard optical fiber interface for connecting the associated camera control unit (the HDCU-3100 or HDCU-2000). While achieving exceptional quality, these cameras can also transmit all digital bi-directional video and audio signals, with a control line and a prompter line, over extremely long distances.

Next-Generation Digital Triax Transmission

With these newly developed third-generation digital triax-based systems, you can transmit detailed high-quality images over a long distance – up to 1,800 meters (5,904 feet)*⁴ with a ø14.5 mm triax cable.

*⁴ Maximum cable length varies with camera system configuration.

Network TRUNK*⁵

The network TRUNK function (LAN port) allows for data transmission between the camera and the CCU at up to 1 Gbps. This supports new system configurations that are being used with various IP-based products.

*⁵ This function can only be used with the fiber system.

ND and CC Filters

The HDC-5500/HDC-3500 and HDC-3100 are equipped with a ND (neutral density) / CC (color correction) filter which can also be remotely controlled by a remote control panel (RCP) or master setup unit (MSU). The HDC-5500 and HDC-3500 have five changeable positions and the HDC-3100 and HDC-3170 have four.

Compact and Lightweight Camera Body

HDC-5500, HDC-3500, HDC-3100, and HDC-3170 cameras incorporate magnesium alloy in their bodies and the HDC-5500 and HDC-3500 also feature carbon fiber reinforced plastic (CFRP) in their outside panels. With this strong yet lightweight design, these cameras are highly mobile and can be operated even in the toughest shooting conditions.

The HDC Series provides stable handling, owing to a low center of gravity. You can easily adjust the shoulder pad into a well-balanced position without needing to use a screwdriver. Also, a wide viewable area beneath the handle provides you with a broad field of view, ideal for handheld camera operation. In every carefully considered aspect, HDC Series studio cameras offer great ergonomic design to increase ease of use.



Rich Focus Assist Functions

The viewfinder detail function adds dedicated image-enhancing edge signals directly to the viewfinder, helping you to recognize a focusing point.

The focus assist indicator displays an indicator for adjustment at the bottom (or another selected position) of the viewfinder frame.

In addition, the HDC-5500, HDC-3500 and HDC-3100 are equipped with an advanced focus position meter function; the return switch can also be utilized as the focus position meter with illumination. Three focus positions can be assigned at the RGB switches of the HDLA-1500 Series Large Lens Adaptor, and the same position data can be assigned at the return switches on the camera's intercom panel. These switches can be lit in red, green, blue or others according to the functions.

This is helpful especially when shooting with a wide-viewing angle.



Flexibility with the HDC Series

Easy Transmission Change (for HDC-5500, HDC-3500 and HDC-3500H)

The transmission system can be easily changed between fiber (HKC-FB30 and HKC-FB50), triax (HKC-TR37), and wireless (HKC-WL50) transmission by replacing parts assembled in the outside panels*¹.

In addition, since all replacement connectors are located in the outside panels, camera balance is maintained.

*¹The optional HKC-CN50 is required to attach an outside panel.

HKC-FB30: Optical Fiber Transmission Adaptor



HKC-FB50: UHB Optical Fiber Transmission Adaptor



HKC-TR37: Digital Triax Transmission Adaptor



HKC-WL50: Wireless Transmission Adaptor



Upgrade Software to Expand Creativity

An upgrade path is provided for your further creative operation. You can select your configuration with the following optional software, including special versions that operate for a limited time period, according to your needs.

HZC-PSF50: PsF-format Software

HZC-PSF50M: PsF-format Software (30-day limited period)

HZC-PSF50W: PsF-format Software (7-day limited period)

HZC-PRV50: 59.94p/50p Software

HZC-PRV50M: 59.94p/50p Software (30-day limited period)

HZC-PRV50W: 59.94p/50p Software (7-day limited period)

HZC-DFR50: Double-speed Capturing Software for Slow Motion
(for HDC-5500 and HDC-3500)

HZC-DFR50M: Double-speed Capturing Software for Slow Motion
(30-day limited period) (for HDC-5500 and HDC-3500)

HZC-DFR50W: Double-speed Capturing Software for Slow Motion
(7-day limited period) (for HDC-5500 and HDC-3500)

HZC-UG50: User Gamma-compatible Software

HZC-UG50M: User Gamma-compatible Software (30-day limited period)

HZC-UG50W: User Gamma-compatible Software (7-day limited period)

HZC-UHD50: 4K format Software (for HDC-5500 and HDC-P50)

HZC-UHD50M: 4K format Software (30-day limited period for HDC-5500 and HDC-P50)

HZC-UHD50W: 4K format Software (7-day limited period for HDC-5500 and HDC-P50)

HZC-UHD50P: 4K format Portable Software (for HDC-5500)

HZC-HFR50: HFR format Software (for HDC-5500 and HDC-P50)

HZC-HFR50M: HFR format Software (30-day limited period for HDC-5500 and HDC-P50)

HZC-HFR50W: HFR format Software (7-day limited period for HDC-5500 and HDC-P50)

HZC-HFR50P: HFR format Portable Software (for HDC-5500)



HDC-5500

Flexibility with the HDC Series

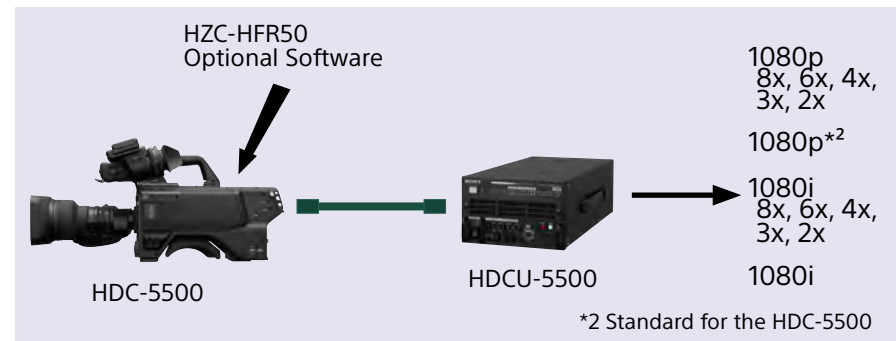
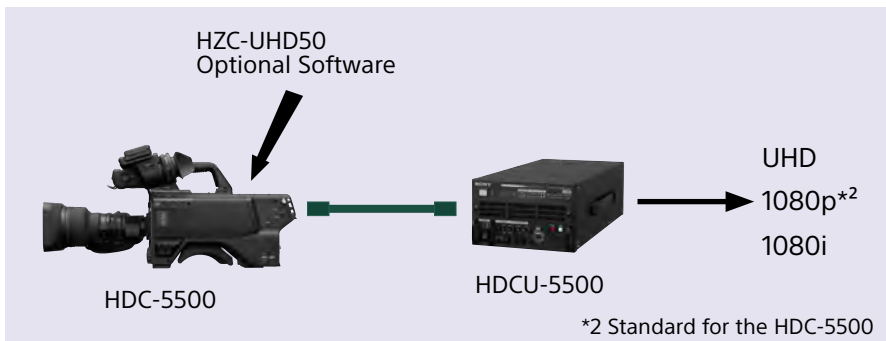
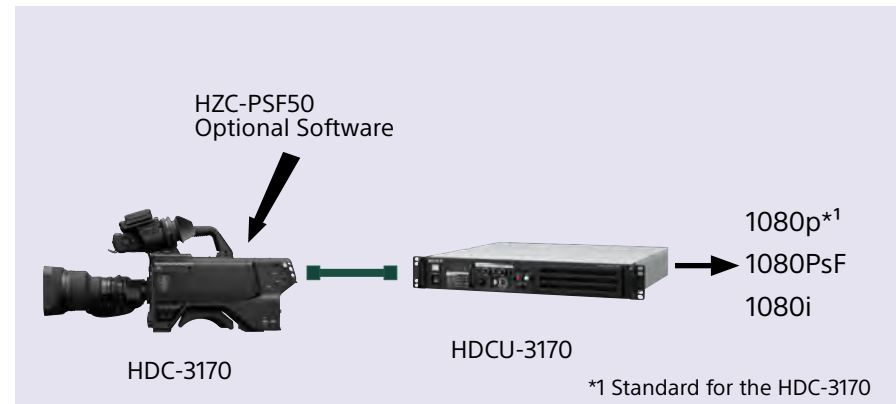
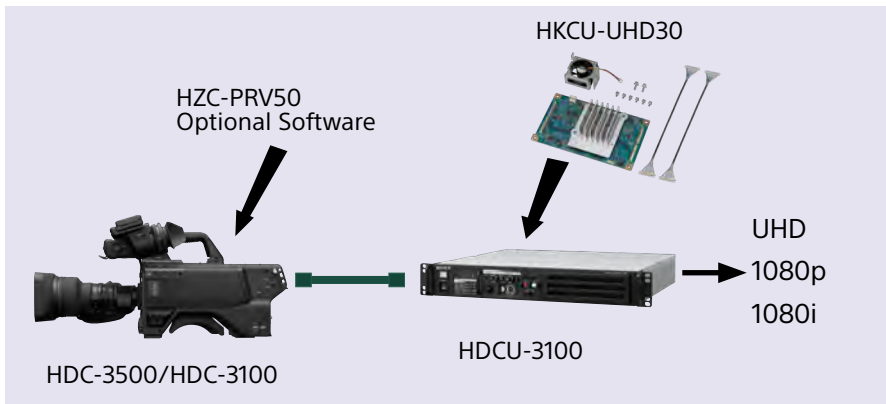
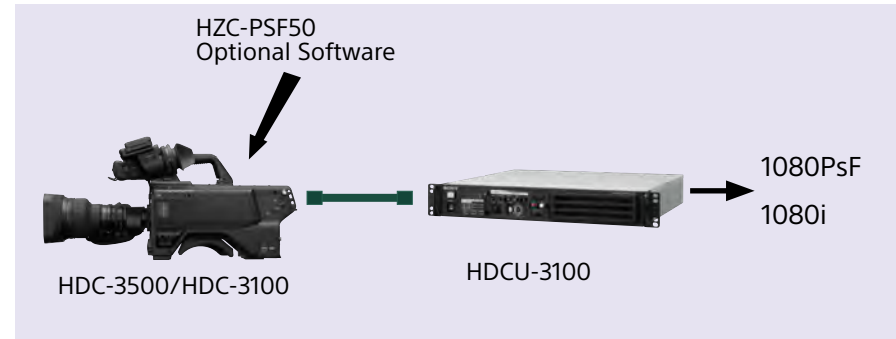
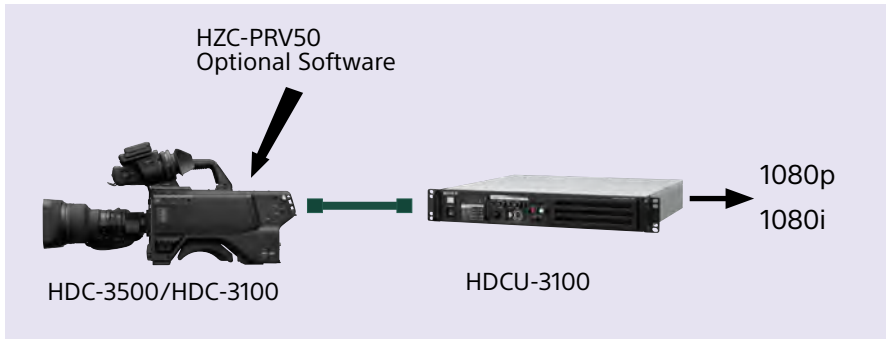

Superior Operability

Wider area for an easier handle grip

It's easy to grip the handle even with gloves on. And visibility through this area has improved. In addition, the ergonomically designed handle enables stable handling of the camera – use your index finger to tightly hold this part of the camera.



Viewfinder position: easy and stylish to use

The position of the viewfinder can be adjusted with ease. You can slide the viewfinder backward or forward and lock it to set its position with just the positioning lever. Its mounting rods are perfectly retracted into the body in a minimized position. As the rods do not protrude inward, they cannot interfere with your hand when gripping the handle.



Excellent Visibility

Camera numbering using electronic paper (for the HDC-5500 and HDC-3500)

An industry first, these camera uses electronic paper (e-ink)-type camera numbers. This numbering changes automatically when the system changes the camera number. In addition, graphics can also be displayed with a number.

Side tally using an LED lamp (for the HDC-5500 and HDC-3500)

A tally lamp is mounted next to the camera number, improving visibility of tally status from the outside.



User-Friendly Interface

Improved layout of connectors

It's easy to pull BNC connectors out of the rear panel because of the ergonomic layout design.



Simple intercom with earphone terminal

Besides the conventional intercom system, a commercially available earphone (4-pole earphones) can be utilized to input and output the intercom audio signal.



Versatile System Components: HDCU-5500 and HDCU-3500

Sony's HDCU-5500 and HDCU-3500 camera control units are next-generation CCUs that perform signal processing, provide an interface to external equipment, and supply power to the camera. In a portable half rack width 3 RU-size, these devices provide a path for IP and 12G-SDI capabilities as an option, including IP on HDC Series optical fiber studio cameras. The HDCU-5500 is capable of ultra-high bit-rate (UHB) transmission for main 4K signals and a 4K video trunk line.

HDCU-5500 Camera Control Unit

- 19-inch 3U Half size CCU for the HDC-5500
- Companion CCU for the HDC-5500
- 12G-SDI and 4K output interface as standard
- The HKCU-SM50 as 3G Single Mode Fiber transmission between the HDCE-100 linked with the HDC-2500 (or HDC-3500).
- Easy web menu settings via network
- IP Tally support (TSL UMD v5.0) as standard



HDCU-5500 Rear view (standard)



HDCU-5500 Rear view
ST 2110 IP interface with optional
HKCU-SFP50



HDCU-5500 Rear view
Single Mode Fiber interface with
optional HKCU-SM50

HDCU-3500 Camera Control Unit

- 19-inch 3U Half size CCU for the HDC-3500
- Companion CCU for the HDC-3500 and HDC-3100
- 12G-SDI and 4K output with an optional software license HZCU-UHD35
- The HKCU-SM30 as 3G Single Mode Fiber transmission between the HDCE-100 linked with the HDC-3500 (or HDC-3100)
- Easy web menu settings via network
- IP Tally support (TSL UMD v5.0) as standard



HDCU-3500 Rear view (standard)



HDCU-3500 Rear view
ST 2110 IP interface with optional
HKCU-SFP50



HDCU-3500 Rear view
Single Mode Fiber interface with
optional HKCU-SM50

Interface Expansion Options HDCU-5500

HKCU-SFP50: ST 2110 IP Interface Kit

The HKCU-SFP50 provides ST 2110 4K/HD IP video/audio and IP intercam capability as system camera operations.

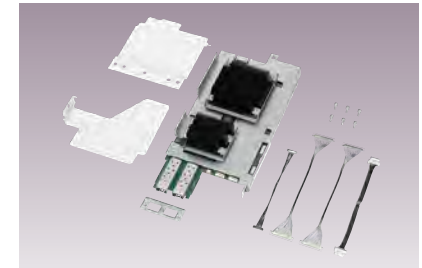

HKCU-SM50: Single Mode Fiber Connection Kit

The HKCU-SM50 is a single mode fiber connection kit between a camera and CCU. With the HKCU-SM50, the maximum distance extends up to 10 km.

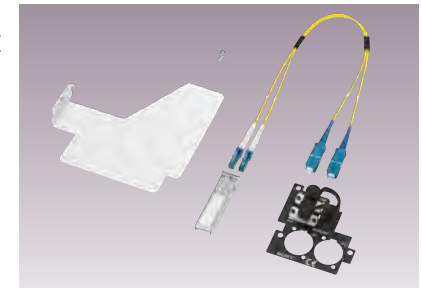

Upgrade Program for 4K

With optional HZCU-UHD35 4K HDR processor software and HZC-PRV50 signal format software, the HDC-3500 and HDC-3100 can be upgraded to create 4K images as well as 4K live HDR (high dynamic range) images.

Software option for system integration

HZCU-SNMP50: SNMP Protocol Software

The HZCU-SNMP50 can add SNMP protocol support to HDCU-3100/3170/3500/5500 cameras. With this option, the CCU can be integrated with system monitoring software.

HZCU-CNFG50: ember+ Protocol Software

The HZCU-CNFG50 can add ember+ protocol support to HDCU-3100/3170/3500/5500 cameras. With this option, the CCU can be integrated with VSM.

Versatile System Components: HDCU-3100 and HDCU-3170

Sony HDCU-3100 and HDCU-3170 Camera Control Units are next-generation CCUs that perform signal processing, provide an interface to external equipment, and supply power to the camera. In a compact 1.5 RU-size, these devices provide a path for IP and 12G-SDI capabilities, including IP on HDC Series optical fiber studio cameras and Triax cameras. These highly compact 1.5 RU-size CCUs fit a standardized 19-inch rack system, ideal for space-limited production areas.

HDCU-3100 Camera Control Unit

- Up to eight 3G-SDI/HD-SDI outputs
- Four sets of 3G-SDI/HD-SDI/SD-SDI return video inputs
- Two-channel teleprompter inputs
- Built-in LAN interface (10BASE-T/100BASE-TX)
- Two-channel data trunk lines (RS-422A or RS-232C) for easy data transmission
- Two-channel microphone outputs (two XLR connectors)
- Easy web menu setting via network
- IP Tally support (TSL UMD v5.0) as standard

HDCU-3170 Camera Control Unit

- Up to eight 3G-SDI/HD-SDI outputs
- One-channel teleprompter input
- Built-in LAN interface (10BASE-T/100BASE-TX)
- A channel data trunk line (RS-422A/RS-232C) for easy data transmission
- Two-channel microphone outputs (two XLR connectors)
- A triax transmission connector is incorporated as standard and an optical fiber connector can also be added by installing an optional HKCU-FB30 Optical Fiber Connector kit. When you are operating in an OB van, it's easy to switch signals between optical fiber and triax cables.
- Easy web menu setting via network
- IP Tally support (TSL UMD v5.0) as standard



HDCU-3170 standard



HDCU-3170 Triax/Fiber transmission with optional HKCU-FB30

Upgrade Program for 4K

With the optional HKCU-UHD30 4K HDR Processor Board and HZC-PRV50 Signal Format Software, the HDC-3500, HDC-3100 and HDC-3170 can be upgraded to create 4K images as well as 4K Live HDR (high dynamic range) images.

HKCU-UHD30: 4K/HDR Processor Board

The HKCU-UHD30 4K HDR Processor Board provides 4K HDR signals for SDI and IP output.

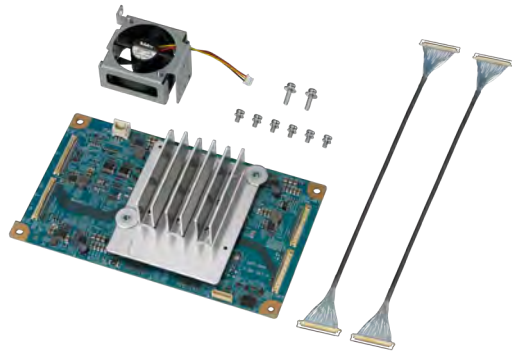

HKCU-SDI30: 12G-SDI Extension Kit

The HKCU-SDI30 is an 12G-SDI expansion kit that adds two connectors for 4K 12G-SDI signals.*1



*1 The HKCU-UHD30 is required for 4K signal output.

Interface Expansion Options

HKCU-FB30: Optical Fiber Connector Kit

The HDCU-3170 Digital Triax CCU can achieve fiber transmission when you install the optional HKCU-FB30. With this new feature, the HDCU-3170 provides selectable triax and fiber transmission in one CCU body.



HKCU-SM30: Single Mode Fiber Connector Kit

The HKCU-SM30 is a single mode fiber connection kit between a camera and CCU.

With the HKCU-SM30, the maximum distance extends up to 10 km.

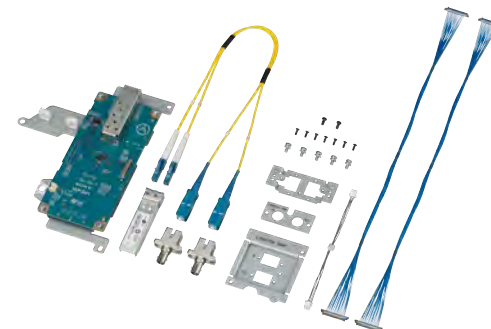

Versatile point-of-view (POV)-style 4K camera: HDC-P50



Compact Design with High Picture Quality

Packed in a highly slim and compact body of only about 112 mm (4 1/2 inches) in width and weighing around 2.4 kg (5 lb 4.7 oz) excluding a lens, the HDC-P50 is equipped with three superb 2/3-inch 4K CMOSs with Global Shutter and Sony-developed digital processing LSI, achieving high picture quality equivalent to that of reputable HDC Series cameras.

The HDC-P50 is ideal for use in space-limited areas such as camera crane jibs, helicopter camera mounts, and stereoscopic 3D camera rigs.

ND and CC Filters

The HDC-P50 is equipped with neutral density (ND) and color correction (CC) optical servo filter units which can be remotely controlled according to lighting condition changes via a remote control panel (RCP) or a master setup unit (MSU).

HD 6x Super Slow Motion*¹

The HDC-P50 captures HD(1080p) images up to 6x super slow motion with an optional software upgrade.

This provides an amazing maximum frame rate of 359.64 fps (59.94 Hz) or 300 fps (50 Hz), allowing you to create sensational super-slow-motion sequences of key moments in a game or event.

*¹ Optional software is required. This function will be available in future.

Multi-Format Operation

This camera supports a wide range of capturing formats such as 1080/59.94i, 1080/50i, 1080/59.94p*², 1080/50p*², 720/59.94p, 720/50p, 1080/23.98PsF*³, 24PsF*³, 25PsF*³, and 29.97PsF*³.

*² Optional HZC-PRV50 software is required.

*³ Optional HZC-PSF50 software is required.

Master Setup Unit and Remote Control Panel

You can use the MSU-1000/MSU-1500 Master Setup Unit (MSU) and RCP-1000 Series Remote Control Panel (RCP) developed to adjust HDC-P50 camera parameters.



MSU-1000 Master Setup Unit



MSU-1500
Master Setup Unit



RCP-1000
Remote Control Panel



RCP-1001
Remote Control Panel



RCP-1500
Remote Control Panel



RCP-3100
Remote Control Panel

System Configuration (LAN connection)

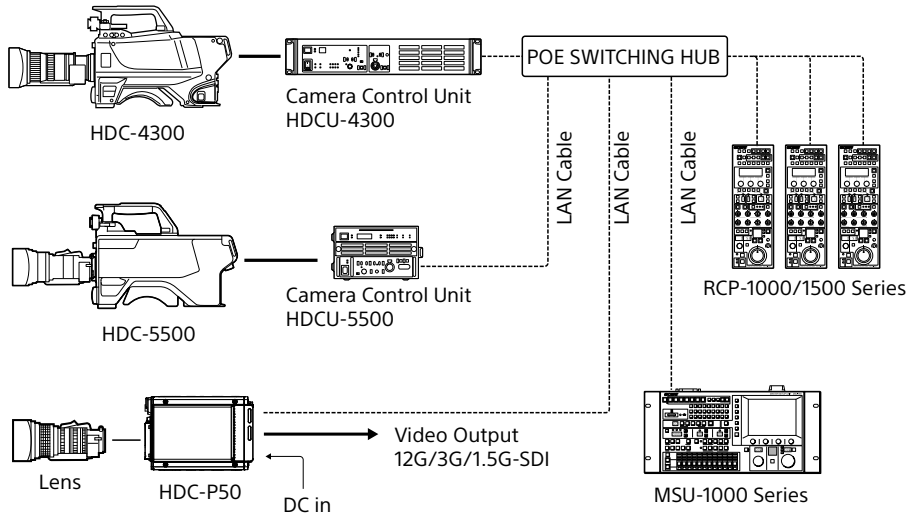

Dimensions

Unit: mm (inches)

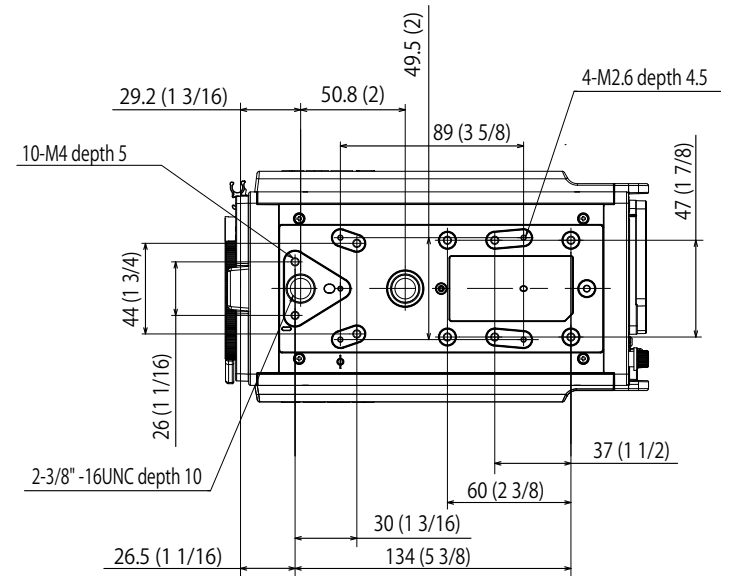

Rear View

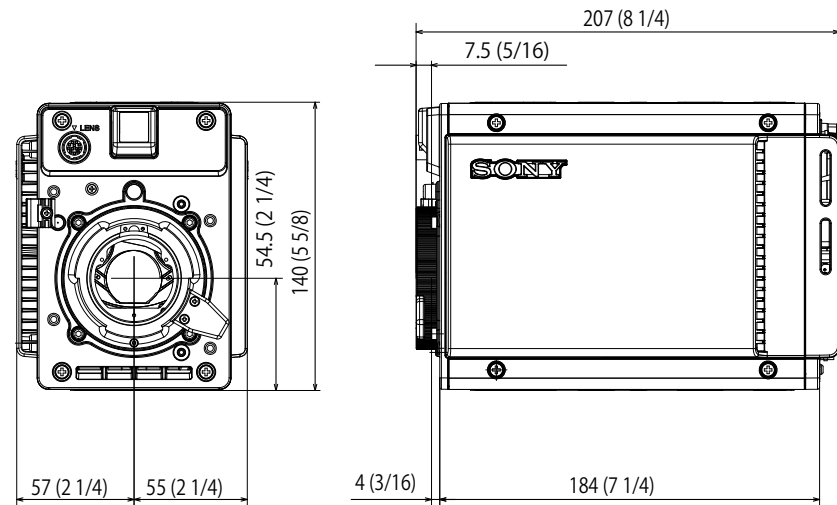

Optional Accessories



MSU-1000
Master Setup Unit



MSU-1500
Master Setup Unit



HDLA-1500
Large Lens Adaptor
(for attachment of the
HDVF-EL70/700A)



HDLA-1505
Large Lens Adaptor
(for attachment of the HDVF-EL75/L770/
C730W/550/C550W)



RCP-1000
Remote Control Panel



RCP-1001
Remote Control Panel



RCP-1500
Remote Control Panel



RCP-3100
Remote Control Panel

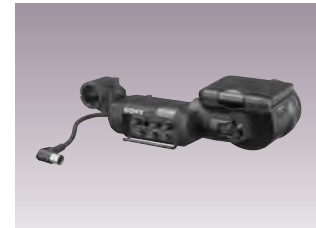

HDVF-EL30
Full HD OLED Viewfinder with
3.5-inch*1 LCD



HDVF-EL20
Full HD OLED Viewfinder



HDVF-EL70
7.4-inch*1 Color HD Viewfinder



HDVF-EL75
7.4-inch*1 Color HD Viewfinder

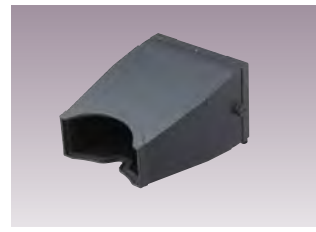

VFH-790
Outdoor Hood for
HDVF-EL70/EL75



HDVF-L750
7-inch*1 LCD Color Viewfinder



HDVF-L770
7-inch*1 LCD Color Viewfinder



HDCE-100
Camera Extension Adaptor



HKCU-SM100
CCU Extension Adaptor



HDCE-200
Camera Extension Adaptor



BKP-7911
Script Holder



CAC-6
Return Video Selector

*1 Viewable area measured diagonally



CAC-12
Mic Holder

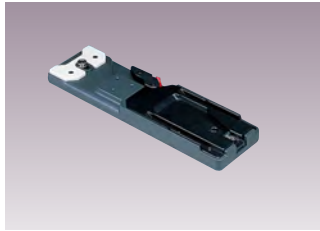

VCT-14
Tripod Adaptor

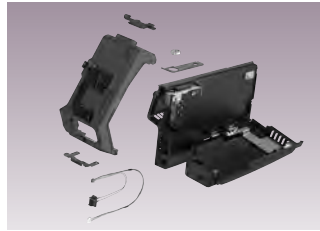

HKC-WL50
Wireless Transmission Adaptor



HKC-FB50
UHB Optical Fiber Transmission Adaptor



HKC-FB30
Optical Fiber Transmission Adaptor



HKC-TR37
Digital Triax Transmission Adaptor

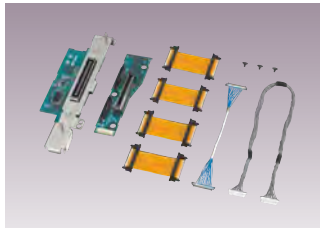

HKC-CN50
Side Panel Attachment Kit



HDCU-5500
Camera Control Unit



HDCU-3500
Camera Control Unit

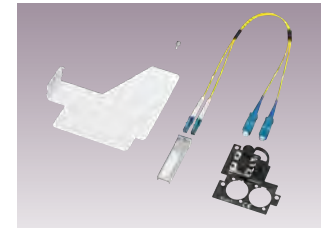

HKCU-SM50
Single Mode Fiber Connector Kit

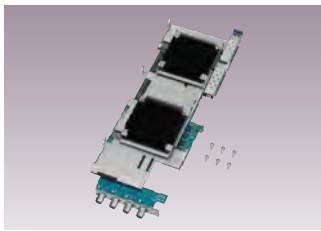

HKCU-FB50
UHB Transmission board kit



HDCU-3100
Fiber Camera Control Unit



HDCU-3170
Triax Camera Control Unit

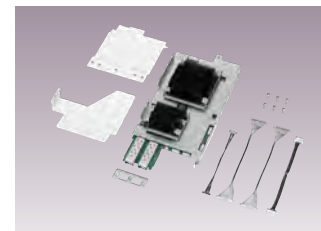

HKCU-SFP50
ST 2110 Interface Kit

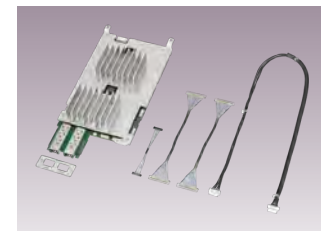

HKCU-SFP30
ST 2110 Interface Kit

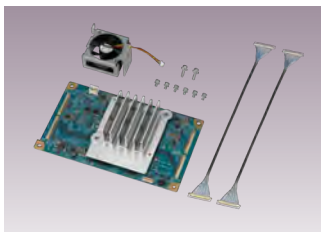

HKCU-UHD30
4K/HDR Processor Board



HKCU-SDI30
12G-SDI Extension Kit

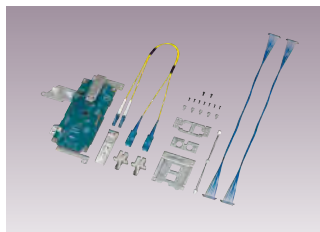

HKCU-SM30
Single Mode Fiber Connector Kit

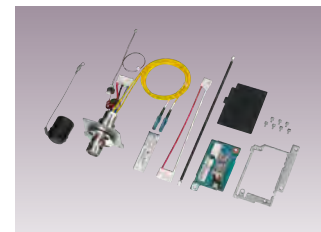

HKCU-FB30
Optical Fiber Connector Kit

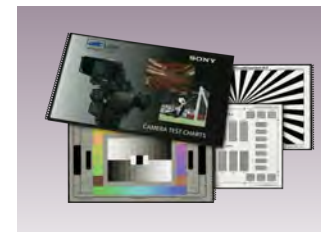

J-712-156-0A
Camera Test Charts

Specifications

HDC-5500/HDC-3500/HDC-3100/HDC-3170 Specifications

	HDC-5500	HDC-3500	HDC-3100	HDC-3170
General				
Power requirements	AC 240 V, 1.4 A (max.), DC 12 V, 9.5 A (max.), DC 240 V, 1.05 A (max.)	AC 240 V, 1.4 A (max.), DC 240 V, 1.05 A (max.)		DC 240 V, 1.05 A (max.)
Operating temperature	-20°C to +45°C (-4°F to 113°F)			
Storage temperature	-20°C to +60°C (-4°F to 140°F)			
Mass	Approx. 5.0 kg (11 lb 0.4 oz) (Unit only)	Approx. 4.9 kg (10 lb 13 oz) (Unit only) Approx. 5.1 kg (11 lb 4 oz) (when HKC-TR37 is attached) Approx. 4.9 kg (10 lb 13 oz) (when HKC-FB30 is attached)	Approx. 4.8 kg (10 lb 9 oz)	Approx. 5.0 kg (11 lb 0.4 oz)
Imager				
Imager	2/3-inch type CMOS sensor with global shutter		2/3 inch type CMOS sensor with global shutter	
Method	3-CMOS, RGB			
Effective resolution (H x V)	QFHD: 3840 x 2160 HD: 1920 x 1080	QFHD: 3840 x 2160 with Option HKCU-Board. HD: 1920 x 1080	HD: 1920 x 1080	
Electrical characteristics				
Sensitivity	F10 with 1080/59.94p F11 with 1080/50p (at 2,000 lx with 89.9% reflectance)		F12 with 1080/59.94i F13 with 1080/50i (at 2,000 lx with 89.9% reflectance)	
Signal-to-noise ratio	-62 dB or higher			
Geometric distortion	Negligible (not including lens distortion)			
Optical system specifications				
Spectrum system	F1.4 prism			
Built-in filters	ND filters 1: CLEAR, 2: 1/4ND, 3: 1/8ND, 4: 1/16ND, 5: 1/64ND CC filters A: Cross filter, B: 3200K (clear), C: 4300K, D: 6300K		1: CLEAR, 2: 1/4ND, 3: 1/16ND, 4: 1/64ND	
Input/output connectors				
CCU	Optical/electrical multi connector (LEMO 3K.93C connector) (x1)			Triax connector (x1)
LENS	12-pin (x1)			
VF	20-pin (x1)			
MIC 1 IN	XLR 3-pin, female (x1)			
AUDIO IN CH1, CH2	XLR 3-pin, female (x1 each) When AUDIO switch is set to MIC: -60 dBu (can be selected up to -20 dBu by menu operation), balanced When AUDIO switch is set to LINE: 0 dBu, balanced			
INTERCOM 1	XLR 5-pin, female (x1)			
INTERCOM 2	XLR 5-pin, female (x1)			No
EARPHONE	4-pole mini jack (x1), (3-pole stereo, 4-pole CTIA standard, 4-pole OMTP standard)		4-pole mini jack (x1), (2-pole mono, 3-pole stereo, 4-pole CTIA standard, 4-pole OMTP standard)	
DC IN	XLR 4-pin (x1), DC 10.5 to 17 V			
DC OUT	4-pin (x1), DC 10.5 to 17 V, max. 0.5 A*1 2-pin (x1), DC 10.5 to 17 V, Max. 2.5 A*1			
SDI 1	BNC (x1)			
SDI 2	BNC (x1)			No
SDI 3	BNC (x1)		No	
SDI MONI	BNC (x1)			
TEST OUT	BNC (x1)			
PROMPTER/GENLOCK	BNC (x1) PROMPTER 1 Vp-p, 75 Ω GENLOCK HD: SMPTE ST274, tri-level sync, 0.6 Vp-p, 75 Ω, SD: Black burst (NTSC: 0.286 Vp-p, 75 Ω/PAL: 0.3 Vp-p, 75 Ω)			
PROMPTER2	No		BNC (x1), 1 Vp-p, 75 Ω	
RET CTRL	6-pin (x1)			
REMOTE	8-pin (x1)			
TRACKER	12-pin (x1)			
CRANE	12-pin (x1)			No
USB	USB 2.0 Type A 4-pin (x1) (for connecting USB drive)			
NETWORK TRUNK	RJ-45 type 8-pin (x1)			No
Supplied accessories				
	Before Using This Unit (1), Operating Instructions (CD-ROM) (1), Cable clamp belt (1 set), Screws (+B3x8) (2), Attached label (1)			Before Using This Unit (1), Operating Instructions (CD-ROM) (1), Cable clamp belt (1 set), Screws (+B3x8) (2), Attached label (1), Camera number label (1)

*1 This may be limited by the imposed load or inputs.

HDCU-5500/HDCU-3500/HDCU-3100/HDCU-3170 Specifications

	HDCU-5500	HDCU-3500	HDCU-3100	HDCU-3170
General				
Power requirements	100 V to 240 V AC, 50/60 Hz			
Current consumption	4.5 A (max.)			
Operating temperature	-10 °C to +40 °C (14 °F to +104 °F)		5 °C to 40 °C (41 °F to 104 °F)	
Storage temperature	-20 °C to +60 °C (-4 °F to +140 °F)			
Mass	Approx. 6.4 kg (14 lb 1.8 oz)	Approx. 6.3 kg (13 lb 14 oz)	Approx. 7.3 kg (16 lb 1.5 oz)	Approx. 8.1 kg (17 lb 14 oz)
Input/output connectors				
CAMERA FIBER	Optical fiber connector (LEMO 3K.93C connector) (x1)			No
CAMERA TRIAX	No			Triax connector (x1)
INTERCOM/TALLY/IO PORT	D-sub 50-pin connector (x1), INTERCOM (PROD/ENG), 4 W: 0 dBu, RTS: 0 dBu, CC: -14 dBu, PGM, 3 systems, 0dBu/-20dBu, TALLY (R, G, Y), FLAG			
RCP/CNU	8-pin multi-connector (x1)			
TRUNK	12-pin (x1)			
LAN-COM	8-pin (x1)			
NETWORK TRUNK	8-pin (x1)			
SDI I/O 1 to 4	3G/HD/SD-SDI I/O, BNC (x4), 3G-SDI: SMPTE ST424/425 Level-A/B, 0.8 Vp-p, 75 Ω, 2.970 Gbps/2.967 Gbps, HD-SDI: SMPTE ST292, 0.8 Vp-p, 75 Ω, 1.485 Gbps/1.4835 Gbps SD-SDI: SMPTE ST259, 0.8 Vp-p, 75 Ω, 270Mbps, 3G-SDI/HD-SDI/SD-SDI, character signal selectable			
REFERENCE IN/OUT	BNC (x2), loop-through output, HD: SMPTE ST274, tri-level sync, 0.6 Vp-p, 75 Ω, SD: Black burst (NTSC: 0.286 Vp-p, 75 Ω/PAL: 0.3 Vp-p, 75 Ω) or NTSC 10F-BB			
Input connectors				
AC IN	AC 100 V to 240 V (x1)			
SDI RET 1 to 4	BNC (x4), 3G-SDI: SMPTE ST424/425, 2.970 Gbps/2.967 Gbps, HD-SDI: SMPTE ST292, 1.485 Gbps/1.4835 Gbps, SD-SDI: SMPTE ST259, 270 Mbps			
PROMPTER 1 PROMPTER 2/VBS-RET	BNC (x2), loop-through output during 1CH mode, terminate internally at 75 Ω during 2CH mode, analog signal, 1.0 Vp-p, 75 Ω			
Output connectors				
AUDIO OUT CH1, CH2	XLR 3-pin, male (x2), 0dBu/-20 dBu/+4 dBu			
CHARACTER/ABS/EBU	BNC (x1), VBS, 1 Vp-p, 75 Ω AES/EBU format VBS/HD and AES/EBU selectable		BNC (x1), VBS, 1 Vp-p, 75 Ω HD SYNC: BTA-S001, tri-level sync, 0.6 Vp-p, 75 Ω SD SYNC: composite sync, 0.3 Vp-p, 75 Ω VBS/HD, SYNC/SD, SYNC selectable	
SDI OUT 1 to 4	3G/HD/SD SDI OUTPUT, BNC (x4), 3G-SDI: SMPTE ST424/425 Level-A/B, 0.8 Vp-p, 75 Ω, 2.970 Gbps/2.967 Gbps, HD-SDI: SMPTE ST292, 0.8 Vp-p, 75 Ω, 1.485 Gbps/1.4835 Gbps SD-SDI: SMPTE ST259, 0.8 Vp-p, 75 Ω, 270 Mbps, 3G-SDI/HD-SDI/SD-SDI, character signal selectable			
UHD SDI A, B	12G/6G/3G/HD SDI OUTPUT, BNC (x2) 12G SDI: SMPTE ST2082, 0.8 Vp-p, 75 Ω, 11.88 Gbps/11.868 Gbps 6G SDI: SMPTE ST2081, 0.8 Vp-p, 75 Ω, 5.940 Gbps/5.934 Gbps 3G SDI: SMPTE ST424/425 Level-A/B, 0.8 Vp-p, 75 Ω, 2.970 Gbps/2.967 Gbps HD SDI: SMPTE ST292, 0.8 Vp-p, 75 Ω, 1.485 Gbps/1.4835 Gbps	12G/3G/HD SDI OUTPUT, BNC (x2) 12G SDI: SMPTE ST2082, 0.8 Vp-p, 75 Ω, 11.88 Gbps/11.868 Gbps * 12G SDI can be selected by installing the HZCU-UHD35. 3G SDI: SMPTE ST424/425 Level-A/B, 0.8 Vp-p, 75 Ω, 2.970 Gbps/2.967 Gbps HD SDI: SMPTE ST292, 0.8 Vp-p, 75 Ω, 1.485 Gbps/1.4835 Gbps	No	
UHD SDI C, D	12G/6G/3G/HD SDI I/O, BNC type (2) 12G SDI: SMPTE ST2082, 0.8 Vp-p, 75 Ω, 11.88 Gbps/11.868 Gbps 6G SDI: SMPTE ST2081, 0.8 Vp-p, 75 Ω, 5.940 Gbps/5.934 Gbps 3G SDI: SMPTE ST424/425 Level-A/B, 0.8 Vp-p, 75 Ω, 2.970 Gbps/2.967 Gbps HD SDI: SMPTE ST292, 0.8 Vp-p, 75 Ω, 1.485 Gbps/1.4835 Gbps	12G/3G/HD SDI I/O, BNC (x2) 12G SDI: SMPTE ST2082, 0.8 Vp-p, 75 Ω, 11.88 Gbps/11.868 Gbps * 12G SDI can be selected by installing the HZCU-UHD35. 3G SDI: SMPTE ST424/425 Level-A/B, 0.8 Vp-p, 75 Ω, 2.970 Gbps/2.967 Gbps HD SDI: SMPTE ST292, 0.8 Vp-p, 75 Ω, 1.485 Gbps/1.4835 Gbps	No	
Supplied accessories				
Number plates (1 set), Before Using this Unit (1), Operating Instructions (CD-ROM) (1)				
Optional accessories				
United States and Canada: Power cord set (1-551-812-XX) Other areas: Power cord set (1-782-929-XX)				
United States and Canada: Plug holder B (2-990-242-01) Other areas: Plug holder C (3-613-640-01)				
CCA-5-3 Connection Cable (3 meters), CCA-5-10 Connection Cable (10 meters)				

Design and specifications are subject to change without notice

Specifications

HDC-P50 Specifications

	HDC-P50
General	
Power requirements	DC 10.5 V to 17 V, 8.2 A (max.)
Operating temperature	-20°C to +45°C (-4°F to +113°F)
Storage temperature	-20°C to +60°C (-4°F to +140°F)
Mass	2.4 kg (5 lb 4.7 oz)
Camera section	
Imager	2/3-inch type CMOS with global shutter
Method	3-CMOS, RGB
Effective resolution (H x V)	QFHD: 3840 × 2160 HD: 1920 × 1080
Signal format	1080/50i, 1080/59.94i, 720/50p, 720/59.94p (1080/23.98PsF, 1080/24PsF, 1080/25PsF, 1080/29.97PsF, 50/59.94p, 4K/50p, 4K/59.94p: option)
Spectrum system	F1.4 prism
Lens mount	Sony bayonet mount
Built-in filters	ND: 1: CLEAR, 2: 1/4ND, 3: 1/8ND, 4: 1/16ND, 5: 1/64ND CC: A: CROSS, B: 3200K, C: 4300K, D: 6300K
Sensitivity (at 2000 lx, 3200K, 89.9% reflectance)	F10 (at 1080/59.94p, 720/59.94p), F11 (at 1080/50p, 720/50p)
Signal-to-noise ratio	-62 dB or higher
Horizontal resolution	2,000 TV lines (at center)
Shutter speed	1/100, 1/125, 1/250, 1/500, 1/1000, 1/2000 sec (1080/59.94i) 1/60, 1/125, 1/250, 1/500, 1/1000, 1/2000 sec (1080/50i)
Inputs/Outputs	
Genlock input	BNC (x1) HD: SMPTE 274M, tri-level sync, 0.6 Vp-p, 75 Ω SD: Black burst (NTSC: 0.286 Vp-p, 75 Ω/PAL: 0.3 Vp-p, 75 Ω)
SDI 1 output	BNC (x1), 12G/3G/1.5G-SDI
SDI 2 output	BNC (x1), 12G/3G/1.5G-SDI
SDI 3 output	BNC (x1), 3G/1.5G-SDI
SDI 4 output	BNC (x1), 3G/1.5G-SDI
SDI MONI	BNC (x1), HD-SDI
EXT I/O	D-sub 15-pin (female) (x1)
REMOTE	8-pin (x1)
LENS	12-pin (x1)
LAN	RJ-45 (x1), 10BASE-T, 100BASE-TX
Supplied accessories	
Tally number plate (1set), CD-ROM (1)	

Distributed by

©2019 Sony Imaging Products & Solutions Inc. All rights reserved.
 Reproduction in whole or in part without written permission is prohibited.
 Features and specifications are subject to change without notice.
 The values for mass and dimension are approximate.
 "SONY" is a registered trademark of Sony Corporation.
 All other trademarks are the property of their respective owners.
 Please visit Sony's professional website or contact your Sony representative
 for specific models available in your region.